

NARDI **COMPRESSORI** **LOW PRESSURE**

Quality system certified
to ISO 9001:2015



COMPRESSORS 8 – 30 BAR

Catalogue



(ENG) NARDI COMPRESSORI was founded in 1965 by the Ghiotto family in Montecchio Maggiore (Vicenza). The symbol  indicates the union of the two names Nardi and Ghiotto owners of the company and leaders in the design and construction of high-tech compressors. In 2008 ongoing investments to improve production processes led to the purchase of a facility of 7000 m² with modern and efficient departments. In 2010, the company was certified UNI EN ISO 9001:2015 with the certifying body TÜV which is among the most qualified in the world. Always careful about production and technology, NARDI COMPRESSORI is proud of having a fully ITALIAN production with testing of each product

individually. Today NARDI COMPRESSORI distributes in over 100 countries around the world its vast range of compressors from 8 bar up to over 500 bar with a production of over 30,000 units each year.

(ITA) NARDI COMPRESSORI è stata fondata nel 1965 dalla famiglia Ghiotto a Montecchio Maggiore (VI). Il simbolo  indica l'unione dei due nomi NARDI e GHIOTTO titolari della azienda, leader nella progettazione e costruzione di compressori ad alto contenuto tecnologico. I continui investimenti atti a migliorare i processi produttivi hanno portato nel 2008 all'acquisto dello stabilimento di 7000 m³ con reparti efficienti e moderni. Nel 2010 l'azienda si è certificata UNI EN ISO 9001:2015 con l'ente certificante TÜV fra i più qualificati al mondo. Sempre attenta alla produzione e alla tecnologia, la NARDI COMPRESSORI vanta di una produzione completamente ITALIANA con collaudi di ogni singolo articolo. Oggi è apprezzata in più di 100 paesi in tutto il mondo con una gamma di compressori che va dai 8 bar fino a oltre i 500 bar e una produzione che supera i 30.000 pezzi prodotti ogni anno.



SPONSOR GP2 2015 - 2020



Packing
Imballo

Weight with box : 7,5 Kg - 16,5 Lbs
Box dimensions : 34 x 16 x 28 (0,016m³)
Quantity EUR PALLET : 100 pcs



Compressor Model	Tank	Cylinders	Air Intake	Pressure	Power	Phase	Revolution	Noise	Weight	Dimensions
Modello Compressore	Serb.	Cilindri	Aria Aspirata	Pressione	Motore	Fase	Giri	Rumore	Peso	Dimensioni
Type	Liters	N°	l/min. - C.F.M. - m ³ /h	Bar - Psi	HP - kW	Type	Rpm	dB	Kg - Lbs	cm (LxWxH)
SILVERSTONE	-	1	100 - 3,5 - 6	8 - 114	0,5 - 0,35	Single	2800	72	7 - 15,4	33 x 15 x 23

With automatic thermal protection

Con protezione termica automatica

SILVERSTONE 2



Packing
Imballo

Weight with box : 11 Kg - 24,2 Lbs
Box dimensions : 41 x 16 x 42 (0,027m³)
Quantity EUR PALLET : 75 pcs



Compressor Model	Tank	Cylinders	Air Intake	Pressure	Power	Phase	Revolution	Noise	Weight	Dimensions
Modello Compressore	Serb.	Cilindri	Aria Aspirata	Pressione	Motore	Fase	Giri	Rumore	Peso	Dimensioni
Type	Liters	N°	l/min. - C.F.M. - m ³ /h	Bar - Psi	HP - kW	Type	Rpm	dB	Kg - Lbs	cm (LxWxH)
SILVERSTONE 2	5	1	100 - 3,5 - 6	8 - 114	0,5 - 0,35	Single	2800	72	10 - 22	41 x 15 x 39

With automatic thermal protection

Con protezione termica automatica

MADE IN ITALY BY NARDI COMPRESSORI

Page 05

Packing
Imballo

Weight with box (ESPRIT 60) :
13,5 Kg - 39,8 Lbs
Box dimensions : 45 x 31 x 33 (0,046 m³)
Quantity EUR PALLET : 25 pcs



Compressor Model	Tank	Cylinders	Air Intake	Pressure	Power	Phase	Revolution	Noise	Weight	Dimensions
Modello Compressore	Serb.	Cilindri	Aria Aspirata	Pressione	Motore	Fase	Giri	Rumore	Peso	Dimensioni
Type	Liters	N°	l/min. - C.F.M. - m ³ /h	Bar - Psi	HP - kW	Type	Rpm	dB	Kg - Lbs	cm (LxWxH)
ESPRIT 3T 60/4	3	2	105 - 3,7 - 6,3	10 - 145	0,75 - 0,5	Single	1400	52	13 - 29	45 x 24 x 28
ESPRIT 3T 60/2	3	2	210 - 7,4 - 12,6	10 - 145	0,75 - 0,5	Single	2800	62	13 - 29	45 x 24 x 28
ESPRIT 3T 65/4	3	2	125 - 4,4 - 7,5	10 - 145	0,90 - 0,65	Single	1400	53	13,5 - 30	45 x 24 x 28
ESPRIT 3T 65/2	3	2	250 - 8,8 - 15	10 - 145	0,90 - 0,65	Single	2800	63	13,5 - 30	45 x 24 x 28

With automatic thermal protection
Con protezione termica automatica

ESPRIT 3 15L.



Packing

Imballo

Weight with box (ESPRIT 60) :

19 Kg - 41,9 Lbs

Box dimensions : 51 x 25 x 43 (0,055m³)

Quantity EUR PALLET : 24 pcs



Compressor Model	Tank	Cylinders	Air Intake	Pressure	Power	Phase	Revolution	Noise	Weight	Dimensions
Modello Compressore	Serb.	Cilindri	Aria Aspirata	Pressione	Motore	Fase	Giri	Rumore	Peso	Dimensioni
Type	Liters	N°	l/min. - C.F.M. - m ³ /h	Bar - Psi	HP - kW	Type	Rpm	dB	Kg - Lbs	cm (LxWxH)
ESPRIT 3 15L. 60/4	15	2	105 - 3,7 - 6,3	10 - 145	0,75 - 0,5	Single	1400	52	18 - 39,7	47 x 22 x 40
ESPRIT 3 15L. 60/2	15	2	210 - 7,4 - 12,6	10 - 145	0,75 - 0,5	Single	2800	62	18 - 39,7	47 x 22 x 40
ESPRIT 3 15L. 65/4	15	2	125 - 4,4 - 7,5	10 - 145	0,90 - 0,65	Single	1400	53	18,5 - 40,8	47 x 22 x 40
ESPRIT 3 15L. 65/2	15	2	250 - 8,8 - 15	10 - 145	0,90 - 0,65	Single	2800	63	18,5 - 40,8	47 x 22 x 40

With automatic thermal protection

Con protezione termica automatica

MADE IN ITALY BY NARDI COMPRESSORI

Page 07



**Packing
Imballo**

Weight with box (ESPRIT 60) :
19 Kg - 41,9 Lbs
Box dimensions : 42 x 39 x 72 (0,118m³)
Quantity EUR PALLET : 15 pcs

Compressor Model	Tank	Cylinders	Air Intake	Pressure	Power	Phase	Revolution	Noise	Weight	Dimensions
Modello Compressore	Serb.	Cilindri	Aria Aspirata	Pressione	Motore	Fase	Giri	Rumore	Peso	Dimensioni
Type	Liters	N°	l/min. - C.F.M. - m ³ /h	Bar - Psi	HP - kW	Type	Rpm	dB	Kg - Lbs	cm (LxWxH)
ESPRIT 1 10L. 60/4	10	2	105 - 3,7 - 6,3	10 - 145	0,75 - 0,5	Single	1400	52	17 - 37,5	41 x 35 x 68
ESPRIT 1 10L. 60/2	10	2	210 - 7,4 - 12,6	10 - 145	0,75 - 0,5	Single	2800	62	17 - 37,5	41 x 35 x 68
ESPRIT 1 10L. 65/4	10	2	125 - 4,4 - 7,5	10 - 145	0,90 - 0,65	Single	1400	53	17,5 - 38,6	41 x 35 x 68
ESPRIT 1 10L. 65/2	10	2	250 - 8,8 - 15	10 - 145	0,90 - 0,65	Single	2800	63	17,5 - 38,6	41 x 35 x 68

With automatic thermal protection
Con protezione termica automatica

ESPRIT SILENCED 5L.



Packing
Imballo

Weight with box (ESPRIT 60) :
21 Kg - 46,3 Lbs
Box dimensions : 42 x 26 x 40 (0,044m³)
Quantity EUR PALLET : 32 pcs



Compressor Model	Tank	Cylinders	Air Intake	Pressure	Power	Phase	Revolution	Noise	Weight	Dimensions
Modello Compressore	Serb.	Cilindri	Aria Aspirata	Pressione	Motore	Fase	Giri	Rumore	Peso	Dimensioni
Type	Liters	N°	l/min. - C.F.M. - m ³ /h	Bar - Psi	HP - kW	Type	Rpm	dB	Kg - Lbs	cm (LxWxH)
ESPRIT SILENCED 5L. 60/4	5	2	105 - 3,7 - 6,3	10 - 145	0,75 - 0,5	Single	1400	48	20 - 44,1	41 x 25 x 39
ESPRIT SILENCED 5L. 60/2	5	2	210 - 7,4 - 12,6	10 - 145	0,75 - 0,5	Single	2800	55	20 - 44,1	41 x 25 x 39
ESPRIT SILENCED 5L. 65/4	5	2	125 - 4,4 - 7,5	10 - 145	0,90 - 0,65	Single	1400	49	20,5 - 45,2	41 x 25 x 39
ESPRIT SILENCED 5L. 65/2	5	2	250 - 8,8 - 15	10 - 145	0,90 - 0,65	Single	2800	56	20,5 - 45,2	41 x 25 x 39

With automatic thermal protection
Con protezione termica automatica

MADE IN ITALY BY NARDI COMPRESSORI

Page 09

**Packing
Imballo**

Weight with box (1,5HP) :
24,5 Kg - 54 Lbs
Box dimensions : 55 x 35 x 44 (0,085m³)
Quantity EUR PALLET : 25 pcs



Compressor Model	Tank	Cylinders	Air Intake	Pressure	Power	Phase	Revolution	Noise	Weight	Dimensions
Modello Compressore	Serb.	Cilindri	Aria Aspirata	Pressione	Motore	Fase	Giri	Rumore	Peso	Dimensioni
Type	Liters	N°	l/min. - C.F.M. - m ³ /h	Bar - Psi	HP - kW	Type	Rpm	dB	Kg - Lbs	cm (LxWxH)
EXTREME 3T 0,75 HP	5	2	200 - 7,0 - 12	10 - 145	0,75 - 0,55	Single	1400	72	20,5 - 45	53 x 31 x 39
EXTREME 3T 1,5 HP	5	2	240 - 8,5 - 14,4	10 - 145	1,50 - 1,1	Single	1400	72	23 - 51	53 x 31 x 39
EXTREME 3T 1,5 HP 15 BAR	5	2	115 - 4,0 - 6,9	15 - 217	1,50 - 1,1	Single	1400	72	23 - 51	53 x 31 x 39
EXTREME 3T 2,0 HP	5	2	400 - 14,1 - 24	10 - 145	2,00 - 1,5	Single	2800	82	26,5 - 58	53 x 31 x 39

With automatic thermal protection

Con protezione termica automatica

EXTREME 3T 5L.



Packing
Imballo

Weight with box : 28,5 Kg - 62,8 Lbs
Box dimensions : 59 x 35 x 44 (0,091m³)
Quantity EUR PALLET : 25 pcs



Compressor Model	Tank	Cylinders	Air Intake	Pressure	Power	Phase	Revolution	Noise	Weight	Dimensions
Modello Compressore	Serb.	Cilindri	Aria Aspirata	Pressione	Motore	Fase	Giri	Rumore	Peso	Dimensioni
Type	Liters	N°	l/min. - C.F.M. - m ³ /h	Bar - Psi	HP - kW	Type	Rpm	dB	Kg - Lbs	cm (LxWxH)
EXTREME 3T 2,0 HP 1400	5	2	350 - 12,4 - 21	10 - 145	2,00 - 1,5	Single	1400	73	27 - 60	58 x 31 x 39

With automatic thermal protection

Con protezione termica automatica

MADE IN ITALY BY NARDI COMPRESSORI

Page 11

Packing
Imballo

Weight with box (1,5 HP) :
32 Kg - 71 Lbs
Box imensions : 75 x 28 x 62 (0,122 m³)
Quantity EUR PALLET : 12 pcs



Compressor Model	Tank	Cylinders	Air Intake	Pressure	Power	Phase	Revolution	Noise	Weight	Dimensions
Modello Compressore	Serb.	Cilindri	Aria Aspirata	Pressione	Motore	Fase	Giri	Rumore	Peso	Dimensioni
Type	Liters	N°	l/min. - C.F.M. - m ³ /h	Bar - Psi	HP - kW	Type	Rpm	dB	Kg - Lbs	cm (LxWxH)
EXTREME 3 30L 0,75 HP	30	2	200 - 7,0 - 12	8 - 114*	0,75 - 0,55	Single	1400	72	28 - 62	70 x 30 x 60
EXTREME 3 30L 1,5 HP	30	2	240 - 8,5 - 14,4	8 - 114*	1,50 - 1,1	Single	1400	72	30,5 - 67	70 x 30 x 60
EXTREME 3 30L 2,0 HP 1400	30	2	350 - 12,4 - 21	8 - 114*	2,00 - 1,5	Single	1400	73	36,5 - 81	70 x 30 x 60
EXTREME 3 30L 2,0 HP	30	2	400 - 14,1 - 24	8 - 114*	2,00 - 1,5	Single	2800	82	34 - 75	70 x 30 x 60

*Available also in max. 10bar

With automatic thermal protection
Con protezione termica automatica

EXTREME 3 50L.



Packing
Imballo

Weight with box (1,5HP) :
38,5 Kg - 85 Lbs
Box dimensions : 83 x 42 x 70 (0,180 m³)
Quantity EUR PALLET : 10 pcs



Compressor Model	Tank	Cylinders	Air Intake	Pressure	Power	Phase	Revolution	Noise	Weight	Dimensions
Modello Compressore	Serb.	Cilindri	Aria Aspirata	Pressione	Motore	Fase	Giri	Rumore	Peso	Dimensioni
Type	Liters	N°	l/min. - C.F.M. - m ³ /h	Bar - Psi	HP - kW	Type	Rpm	dB	Kg - Lbs	cm (LxWxH)
EXTREME 3 50L 0,75 HP	50	2	200 - 7,0 - 12	8 - 114*	0,75 - 0,55	Single	1400	72	33,5 - 74	81 x 40 x 69
EXTREME 3 50L 1,5 HP	50	2	240 - 8,5 - 14,4	8 - 114*	1,50 - 1,1	Single	1400	72	36 - 80	81 x 40 x 69
EXTREME 3 50L 2,0 HP 1400	50	2	350 - 12,4 - 21	8 - 114*	2,00 - 1,5	Single	1400	73	43 - 95	81 x 40 x 69
EXTREME 3 50L 2,0 HP	50	2	400 - 14,1 - 24	8 - 114*	2,00 - 1,5	Single	2800	82	39,5 - 87	81 x 40 x 69

*Available also in max. 10bar

With automatic thermal protection
Con protezione termica automatica

MADE IN ITALY BY NARDI COMPRESSORI

Page 13

**Packing
Imballo**

Weight with box (1,5HP) :
27 Kg - 59,5 Lbs
Box dimensions : 42 x 40 x 74 (0,118m³)
Quantity EUR PALLET : 15 pcs



Compressor Model	Tank	Cylinders	Air Intake	Pressure	Power	Phase	Revolution	Noise	Weight	Dimensions
Modello Compressore	Serb.	Cilindri	Aria Aspirata	Pressione	Motore	Fase	Giri	Rumore	Peso	Dimensioni
Type	Liters	N°	l/min. - C.F.M. - m ³ /h	Bar - Psi	HP - kW	Type	Rpm	dB	Kg - Lbs	cm (LxWxH)
EXTREME 1 10L 0,75 HP	10	2	200 - 7,0 - 12	10 - 145	0,75 - 0,55	Single	1400	72	22,5 - 50	42 x 39 x 72
EXTREME 1 10L 1,5 HP	10	2	240 - 8,5 - 14,4	10 - 145	1,50 - 1,1	Single	1400	72	25 - 55	42 x 39 x 72
EXTREME 1 10L 2,0 HP 1400	10	2	350 - 12,4 - 21	10 - 145	2,00 - 1,5	Single	1400	73	30 - 66	42 x 39 x 72
EXTREME 1 10L 2,0 HP	10	2	400 - 14,1 - 24	10 - 145	2,00 - 1,5	Single	2800	82	28,5 - 63	42 x 39 x 72

With automatic thermal protection
Con protezione termica automatica

EXTREME 1 25L.



Packing

Imballo

Weight with box (1,5HP) :

35 Kg - 72,8 Lbs

Box dimensions : 56 x 62 x 85 (0,216 m³)

Quantity EUR PALLET : 8 pcs

Compressor Model	Tank	Cylinders	Air Intake	Pressure	Power	Phase	Revolution	Noise	Weight	Dimensions
Modello Compressore	Serb.	Cilindri	Aria Aspirata	Pressione	Motore	Fase	Giri	Rumore	Peso	Dimensioni
Type	Liters	N°	l/min. - C.F.M. - m ³ /h	Bar - Psi	HP - kW	Type	Rpm	dB	Kg - Lbs	cm (LxWxH)
EXTREME 1 25L 0,75 HP	25	2	200 - 7,0 - 12	8 - 114*	0,75 - 0,55	Single	1400	72	30,5 - 67	54 x 60 x 83
EXTREME 1 25L 1,50 HP	25	2	240 - 8,5 - 14,4	8 - 114*	1,50 - 1,1	Single	1400	72	33 - 73	54 x 60 x 83
EXTREME 1 25L 2,00 HP 1400	25	2	350 - 12,4 - 21	8 - 114*	2,00 - 1,5	Single	1400	73	38,5 - 85	54 x 60 x 83
EXTREME 1 25L 2,00 HP	25	2	400 - 14,1 - 24	8 - 114*	2,00 - 1,5	Single	2800	82	36,5 - 80	54 x 60 x 83

*Available also in max. 10bar

With automatic thermal protection

Con protezione termica automatica

MADE IN ITALY BY NARDI COMPRESSORI

Page 15

**Packing
Imballo**

Weight with box (2,0 HP 1400) :
55 Kg - 121,3 Lbs
Box dimensions : 76 x 69 x 61 (0,320 m³)
Quantity EUR PALLET : 4 pcs



Compressor Model	Tank	Cylinders	Air Intake	Pressure	Power	Phase	Revolution	Noise	Weight	Dimensions
Modello Compressore	Serb.	Cilindri	Aria Aspirata	Pressione	Motore	Fase	Giri	Rumore	Peso	Dimensioni
Type	Liters	N°	l/min. - C.F.M. - m ³ /h	Bar - Psi	HP - kW	Type	Rpm	dB	Kg - Lbs	cm (LxWxH)
EXTREME TN 22L 0,75 HP	11+11	2	200 - 7,0 - 12	10 - 145	0,75 - 0,55	Single	1400	72	47,5 - 105	75 x 67 x 56
EXTREME TN 22L 1,50 HP	11+11	2	240 - 8,5 - 14,4	10 - 145	1,50 - 1,1	Single	1400	72	50 - 110	75 x 67 x 56
EXTREME TN 22L 2,00 HP 1400	11+11	2	350 - 12,4 - 21	10 - 145	2,00 - 1,5	Single	1400	73	55 - 121	75 x 67 x 56
EXTREME TN 22L 2,00 HP	11+11	2	400 - 14,1 - 24	10 - 145	2,00 - 1,5	Single	2800	82	53 - 116	75 x 67 x 56
EXTREME TN 22L 2,50 HP	11+11	4	480 - 17 - 29	10 - 145	2,50 - 1,84	Single	1400	73	58 - 128	75 x 67 x 56
EXTREME TN 22L 3,00 HP	11+11	4	600 - 21,2 - 36	10 - 145	3,00 - 2,20	Three	1400	73	60 - 132	75 x 67 x 56

With automatic thermal protection
Con protezione termica automatica

EXTREME TN 50L.



Packing
Imballo

Weight with box (2,5HP) :
76 Kg - 167 Lbs
Box dimensions : 95 x 78 x 70 (0,519 m³)
Quantity EUR PALLET : 2 pcs



Compressor Model	Tank	Cylinders	Air Intake	Pressure	Power	Phase	Revolution	Noise	Weight	Dimensions
Modello Compressore	Serb.	Cilindri	Aria Aspirata	Pressione	Motore	Fase	Giri	Rumore	Peso	Dimensioni
Type	Liters	N°	l/min. - C.F.M. - m ³ /h	Bar - Psi	HP - kW	Type	Rpm	dB	Kg - Lbs	cm (LxWxH)
EXTREME TN 50L 1,50 HP	25+25	2	240 – 8,5 – 14,4	10 – 145	1,50 – 1,1	Single	1400	72	62 – 137	93 x 75 x 65
EXTREME TN 50L 2,00 HP 1400	25+25	2	350 – 12,4 – 21	10 – 145	2,00 – 1,5	Single	1400	73	67 – 148	93 x 75 x 65
EXTREME TN 50L 2,00 HP	25+25	2	400 – 14,1 – 24	10 – 145	2,00 – 1,5	Single	2800	82	65 – 143	93 x 75 x 65
EXTREME TN 50L 2,50 HP	25+25	4	480 – 17 – 29	10 – 145	2,50 – 1,84	Single	1400	73	70 – 155	93 x 75 x 65
EXTREME TN 50L 3,00 HP	25+25	4	600 – 21,2 – 36	10 – 145	3,00 – 2,20	Three	1400	73	72 – 159	93 x 75 x 65

With automatic thermal protection

Con protezione termica automatica

MADE IN ITALY BY NARDI COMPRESSORI

Page 17



Packing
Imballo

Weight with box : 55 Kg - 120 Lbs
Box dimensions : 70 x 70 x 55 (0,270 m³)
Quantity EUR PALLET : 4 pcs

Compressor Model	Tank	Cylinders	Air Intake	Pressure	Power	Phase	Revolution	Noise	Weight	Dimensions
Modello Compressore	Serb.	Cilindri	Aria Aspirata	Pressione	Motore	Fase	Giri	Rumore	Peso	Dimensioni
Type	Liters	N°	l/min. - C.F.M. - m ³ /h	Bar - Psi	HP - kW	Type	Rpm	dB	Kg - Lbs	cm (LxWxH)
EXTREME 2TN 1,50 HP	25	2	240 - 8,5 - 14,4	10 - 145	1,50 - 1,1	Single	1400	72	44 - 97	67 x 65 x 48
EXTREME 2TN 2,00 HP 1400	25	2	350 - 12,4 - 21	10 - 145	2,00 - 1,5	Single	1400	73	49 - 108	67 x 65 x 48
EXTREME 2TN 2,00 HP	25	2	400 - 14,1 - 24	10 - 145	2,00 - 1,5	Single	2800	82	47.5 - 104	67 x 65 x 48

With automatic thermal protection
Con protezione termica automatica

EXTREME 4 90L.



Packing
Imballo

Weight with box : 76,5 Kg - 169 Lbs
Box dimensions : 113 x 59 x 84 (0,541 m³)
Quantity EUR PALLET : 2 pcs



Compressor Model	Tank	Cylinders	Air Intake	Pressure	Power	Phase	Revolution	Noise	Weight	Dimensions
Modello Compressore	Serb.	Cilindri	Aria Aspirata	Pressione	Motore	Fase	Giri	Rumore	Peso	Dimensioni
Type	Liters	N°	l/min. - C.F.M. - m ³ /h	Bar - Psi	HP - kW	Type	Rpm	dB	Kg - Lbs	cm (LxWxH)
EXTREME 4 90L 2,00 HP	90	2	350 - 12,4 - 21	10 - 145	2,00 - 1,5	Single	1400	73	62 - 137	107 x 57 x 81
EXTREME 4 90L 2,50 HP	90	4	480 - 17 - 29	10 - 145	2,50 - 1,84	Single	1400	73	70 - 155	107 x 57 x 81
EXTREME 4 90L 3,00 HP	90	4	600 - 21,2 - 36	10 - 145	3,00 - 2,20	Three	1400	75	76 - 163	107 x 57 x 81

With automatic thermal protection

Con protezione termica automatica

MADE IN ITALY BY NARDI COMPRESSORI

Page 19

Packing

Imballo

Weight with box : 44 Kg - 97 Lbs
 Box dimensions : 52x 57,5 x 72 (0,21 m³)
 Quantity EUR PALLET : 4 pcs



Compressor Model	Tank	Cylinders	Air Intake	Pressure	Power	Phase	Revolution	Noise	Weight	Dimensions
Modello Compressore	Serb.	Cilindri	Aria Aspirata	Pressione	Motore	Fase	Giri	Rumore	Peso	Dimensioni
Type	Liters	N°	l/min. - C.F.M. - m ³ /h	Bar - Psi	HP - kW	Type	Rpm	dB	Kg - Lbs	cm (LxWxH)
EXTREME 2 25L 0,75 HP	25	2	200 - 7,0 - 12	8 - 114	0,75 - 0,55	Single	1400	66	36 - 79,5	50 x 43 x 85
EXTREME 2 25L 1,50 HP	25	2	240 - 8,5 - 14,4	8 - 114	1,50 - 1,1	Single	1400	66	38,5 - 85	50 x 43 x 85
EXTREME 2 25L 2,00 HP	25	2	350 - 12,4 - 21	8 - 114	2,00 - 1,5	Single	1400	67	41 - 90	50 x 43 x 85

With automatic thermal protection

Con protezione termica automatica

EXTREME 2 SIL. 50L.



Packing
Imballo

Weight with box : 49 Kg - 108 Lbs
Box dimensions : 60 x 45 x 86 (0,23 m³)
Quantity EUR PALLET : 4 pcs



Compressor Model	Tank	Cylinders	Air Intake	Pressure	Power	Phase	Revolution	Noise	Weight	Dimensions
Modello Compressore	Serb.	Cilindri	Aria Aspirata	Pressione	Motore	Fase	Giri	Rumore	Peso	Dimensioni
Type	Liters	N°	l/min. - C.F.M. - m ³ /h	Bar - Psi	HP - kW	Type	Rpm	dB	Kg - Lbs	cm (LxWxH)
EXTREME 2 50L 0,75 HP	50	2	200 - 7,0 - 12	8 - 114	0,75 - 0,55	Single	1400	66	42 - 92,5	59 x 43 x 85
EXTREME 2 50L 1,50 HP	50	2	240 - 8,5 - 14,4	8 - 114	1,50 - 1,1	Single	1400	66	45 - 99	59 x 43 x 85
EXTREME 2 50L 2,00 HP	50	2	350 - 12,4 - 21	8 - 114	2,00 - 1,5	Single	1400	67	47 - 103	59 x 43 x 85

With automatic thermal protection
Con protezione termica automatica

MADE IN ITALY BY NARDI COMPRESSORI

Page 21

**Packing
Imballo**

Weight with box (1,5HP) :
83 Kg - 183 Lbs
Box dimensions : 77 x 52 x 84 (0,337 m³)
Quantity EUR PALLET : 2 pcs



Compressor Model	Tank	Cylinders	Air Intake	Pressure	Power	Phase	Revolution	Noise	Weight	Dimensions
Modello Compressore	Serb.	Cilindri	Aria Aspirata	Pressione	Motore	Fase	Giri	Rumore	Peso	Dimensioni
Type	Liters	N°	l/min. - C.F.M. - m ³ /h	Bar - Psi	HP - kW	Type	Rpm	dB	Kg - Lbs	cm (LxWxH)
EXTREME SILENCED 50L. 0,75	50	2	200 - 7,0 - 12	8 - 114*	0,75 - 0,55	Single	1400	61	80,5 - 177	72 x 50 x 82
EXTREME SILENCED 50L. 1,50	50	2	240 - 8,5 - 14,4	8 - 114*	1,50 - 1,1	Single	1400	61	83 - 183	72 x 50 x 82
EXTREME SILENCED 50L. 2,00	50	2	350 - 12,4 - 21	8 - 114*	2,00 - 1,5	Single	1400	62	88,5 - 195	72 x 50 x 82
EXTREME SILENCED 50L. 2,00	50	2	400 - 14,1 - 24	8 - 114*	2,00 - 1,5	Single	2800	67	86,5 - 190	72 x 50 x 82

*Available also in max. 10bar

With automatic thermal protection

Con protezione termica automatica

THE NEW NARDI LP CONTROL DEVICE - TOTAL CONTROL, COMPLETELY INDEPENDENT, ENERGY SAVING EFFICIENCY AND SAFETY RELIABILITY OF NARDI COMPRESSORI.

(ENG) This is an automatic electronic controller, flexible and reliable with a large display and touch commands in an easy-to-use modern and compact design. The *LP CONTROL DEVICE* controls up to three pump units autonomously depending on the air quantity requirement of the user which rules the starting up of a single or more pump units. Therefore, the amount of air needed would give the system the input to run the pump units one by one to cater for the air quantity needed. When a limited amount of air is needed, the *LP CONTROL DEVICE* starts a single pump unit, on rotation, this way all pump units will have an equal working time. If more air is needed and a single pump unit is not enough, then the *LPCD* will start the second electric motor and in case more power is needed to reach the pressure needed, it will also run the third electric motor. This kind of working sequence of the pump units is an important energy saver since it avoids frequent and high peaks of electrical consumption. In manual mode, during maintenance operations on one or more pump units, the user selects which pump unit to run and which one/s to keep turned off.

The automatic control device memorizes the total working hours of the compressor and the working hours of every single pump unit and dryer installed. The motor switches have a thermal control which, in case of an electric overload, stops the motor and informs the automatic system of an ongoing malfunction. This will immediately start another motor this way there is no halt in the work of the user. The *LPCD* launches a message when the compressor is due for regular maintenance since the working hours of all pump units on the compressor are equal, and also in case any alarm activates. It is possible to collocate up to 10 *LP CONTROL DEVICES*, therefore a maximum of 30 pump units by means of an RS485 connection.

This controlled system consents a better stability of the process, optimization of the compressor and the pumping units, maximization of the working hours, reduction of energy costs and minimum maintenance operations. Upon request, it is possible to add an extra module to have the *LPCD* send notifications to a determined email address giving real time information about the conditions of the compressor (IoT system).

IL NUOVO NARDI LP CONTROL DEVICE - TOTALE CONTROLLO, COMPLETA AUTONOMIA, EFFICIENTE RISPARMIO ENERGETICO E L’AFFIDABILE SICUREZZA NARDI COMPRESSORI.

(ITA) Sistema di gestione elettronico automatico, flessibile ed affidabile, grande display e comoda pulsantiera, di facile utilizzo e dal design moderno e compatto. Il sistema di gestione *LP CONTROL DEVICE* comanda fino a tre gruppi pompanti in maniera autonoma, in base alla richiesta d’aria da parte dell’utente. L’avviamento di uno o più gruppi pompanti, è dato dal consumo d’aria dell’utente. In base alla quantità di aria richiesta, la gestione automatica *LP CONTROL DEVICE* accenderà uno alla volta i motori elettrici in base al fabbisogno d’aria. Se il consumo d’aria è ridotto, farà partire un solo motore, a rotazione con gli altri due, in base al monte ore di lavoro accumulato. Se invece il fabbisogno d’aria è più elevato ed un solo pompante non è sufficiente, allora la gestione automatica farà partire anche il secondo motore elettrico, e di conseguenza, a valori di pressione stabili, accenderà anche il terzo motore elettrico. Questo tipo di gestione dei pompanti, fa risparmiare corrente elettrica ed evita spunti di consumo elettrico frequenti e troppo elevati. In modalità manuale invece, è l’utente a decidere quale gruppo pompante utilizzare e quale invece fermare, in caso di manutenzione ad uno o più dei pompanti.

Il sistema di gestione automatico *LP CONTROL DEVICE* controlla le ore di lavoro totali del compressore e le ore di lavoro di ogni singolo gruppo pompante e, di conseguenza, anche degli essiccatori. Il comando motori è provvisto di controllo termico, che in caso di eccessivo assorbimento di corrente elettrica, ferma il motore, comunica alla gestione automatica il malfunzionamento, e fa partire subito un altro motore elettrico, così da non fermare l’utente nel suo lavoro. Il sistema avvisa quando il compressore deve fare la manutenzione programmata ed ogni eventuale allarme riscontrato. La manutenzione viene effettuata su tutti i gruppi pompanti durante la stessa manutenzione, in quanto le ore di lavoro sono uguali per tutti i pompanti presenti sul compressore. È possibile affiancare e collegare tra loro fino a 10 *LP CONTROL DEVICE*, quindi fino a 30 gruppi pompanti, tramite collegamento RS485.

Questo sistema di gestione controllata, consente maggiore stabilità del processo, l’ottimizzazione del compressore e dei gruppi pompanti, l’ottimizzazione dei tempi di lavoro, la riduzione del costo energetico e manutenzione minima. A richiesta, è possibile aggiungere il modulo per la comunicazione dei guasti tramite mail, ad un determinato indirizzo di posta elettronica, per essere sempre informati in tempo reale sulle condizioni del compressore (sistema IoT).



Packing
Imballo

Weight with box (9,0HP) :
280 Kg - 617 Lbs
Box dimensions : 170 x 95 x 110 (1,8 m³)
Quantity EUR PALLET : 1 pc



Compressor Model	Tank	Cylinders	Air Intake	Pressure	Power	Phase	Revolution	Noise	Weight	Dimensions
Modello Compressore	Serb.	Cilindri	Aria Aspirata	Pressione	Motore	Fase	Giri	Rumore	Peso	Dimensioni
Type	Liters	N°	l/min. - C.F.M. - m ³ /h	Bar - Psi	HP - kW	Type	Rpm	dB	Kg - Lbs	cm (LxWxH)
EXTREME 4 270L 3,0 HP	270	4	600 - 21,2 - 36	10 - 145	3,00 - 2,2	Three	1400	73	116 - 255	160 x 64 x 87
EXTREME 4 270L 6,0 HP	270	8	1200 - 42,4 - 72	10 - 145	6,00 - 4,4	Three	1400	74	165 - 364	160 x 64 x 87
EXTREME 4 270L 9,0 HP	270	12	1800 - 63,6 - 108	10 - 145	9,00 - 6,6	Three	1400	75	198 - 436	160 x 64 x 87

With automatic thermal protection

Con protezione termica automatica

EXTREME 4 500L.



Packing
Imballo

Weight with box (9,0HP) :
340 Kg - 750 Lbs
Box dimensions : 200 x 120 x 120 (2,9 m³)
Quantity EUR PALLET : 1 pc



Compressor Model	Tank	Cylinders	Air Intake	Pressure	Power	Phase	Revolution	Noise	Weight	Dimensions
Modello Compressore	Serb.	Cilindri	Aria Aspirata	Pressione	Motore	Fase	Giri	Rumore	Peso	Dimensioni
Type	Liters	N°	l/min. - C.F.M. - m ³ /h	Bar - Psi	HP - kW	Type	Rpm	dB	Kg - Lbs	cm (LxWxH)
EXTREME 4 500L 6,0 HP	500	8	1200 - 42,4 - 72	10 - 145	6,00 - 4,4	Three	1400	74	220 - 485	195 x 64 x 110
EXTREME 4 500L 9,0 HP	500	12	1800 - 63,6 - 108	10 - 145	9,00 - 6,6	Three	1400	75	253 - 558	195 x 64 x 110

With automatic thermal protection
Con protezione termica automatica

MADE IN ITALY BY NARDI COMPRESSORI

Page 25

Packing
Imballo

Weight with box (9,0HP) :
280 Kg - 617 Lbs
Box dimensions : 170 x 95 x 110 (1,8 m³)
Quantity EUR PALLET : 1 pc



Compressor Model	Tank	Cylinders	Air Intake	Pressure	Power	Phase	Revolution	Noise	Weight	Dimensions
Modello Compressore	Serb.	Cilindri	Aria Aspirata	Pressione	Motore	Fase	Giri	Rumore	Peso	Dimensioni
Type	Liters	N°	l/min. - C.F.M. - m ³ /h	Bar - Psi	HP - kW	Type	Rpm	dB	Kg - Lbs	cm (LxWxH)
EXTREME 4/21B 270L 6,0	270	8	520 - 18,4 - 31,2	21 - 305	6,00 - 4,4	Three	1400	74	185 - 408	160 x 64 x 87
EXTREME 4/21B 270L 9,0	270	12	780 - 27,6 - 46,8	21 - 305	9,00 - 6,6	Three	1400	75	218 - 480	160 x 64 x 87

With automatic thermal protection

Con protezione termica automatica

EXTREME 4 500L. 21 Bar



Packing
Imballo

Weight with box (9,0HP) :
340 Kg - 750 Lbs
Box dimensions : 200 x 120 x 120 (2,9 m³)
Quantity EUR PALLET : 1 pc



Compressor Model	Tank	Cylinders	Air Intake	Pressure	Power	Phase	Revolution	Noise	Weight	Dimensions
Modello Compressore	Serb.	Cilindri	Aria Aspirata	Pressione	Motore	Fase	Giri	Rumore	Peso	Dimensioni
Type	Liters	N°	l/min. - C.F.M. - m ³ /h	Bar - Psi	HP - kW	Type	Rpm	dB	Kg - Lbs	cm (LxWxH)
EXTREME 4/21B 500L 6,0 HP	500	8	520 - 18,4 - 31,2	21 - 305	6,00 - 4,4	Three	1400	74	240 - 530	195 x 64 x 110
EXTREME 4/21B 500L 9,0 HP	500	12	780 - 27,6 - 46,8	21 - 305	9,00 - 6,6	Three	1400	75	273 - 600	195 x 64 x 110

With automatic thermal protection
Con protezione termica automatica

MADE IN ITALY BY NARDI COMPRESSORI

Page 27

Packing
Imballo

Weight with box : 40 Kg - 88 Lbs
Box dimensions : 70 x 60 x 50 (0,210 m³)
Quantity EUR PALLET : 12 pcs



Compressor Model	Tank	Cylinders	Air Intake	Pressure	Power	Phase	Revolution	Noise	Weight	Dimensions
Modello Compressore	Serb.	Cilindri	Aria Aspirata	Pressione	Motore	Fase	Giri	Rumore	Peso	Dimensioni
Type	Liters	N°	l/min. - C.F.M. - m ³ /h	Bar - Psi	HP - kW	Type	Rpm	dB	Kg - Lbs	cm (LxWxH)
SUPER EXTREME TN 18L.	18	2	130 - 4,6 - 7,8	30 - 435	2,20 - 1,6	Single	1400	72	34 - 75	62 x 50 x 40

With automatic thermal protection
Con protezione termica automatica

SUPER EXTREME 1 TN 30 Bar



Packing
Imballo

Weight with box : 60 Kg - 132 Lbs
Box dimensions : 70 x 70 x 55 (0,270 m³)
Quantity EUR PALLET : 4 pcs



Compressor Model	Tank	Cylinders	Air Intake	Pressure	Power	Phase	Revolution	Noise	Weight	Dimensions
Modello Compressore	Serb.	Cilindri	Aria Aspirata	Pressione	Motore	Fase	Giri	Rumore	Peso	Dimensioni
Type	Liters	N°	l/min. - C.F.M. - m ³ /h	Bar - Psi	HP - kW	Type	Rpm	dB	Kg - Lbs	cm (LxWxH)
SUPER EXTREME 1 TN 18L.	18	2	130 - 4,6 - 7,8	30 - 435	2,20 - 1,6	Single	1400	72	57 - 125	67 x 65 x 48

With automatic thermal protection

Con protezione termica automatica

MADE IN ITALY BY NARDI COMPRESSORI

Page 29

Packing
Imballo

Weight with box : 50 Kg - 110 Lbs
Box dimensions : 62 x 65 x 85 (0,216 m³)
Quantity EUR PALLET : 4 pcs



Compressor Model	Tank	Cylinders	Air Intake	Pressure	Power	Phase	Revolution	Noise	Weight	Dimensions
Modello Compressore	Serb.	Cilindri	Aria Aspirata	Pressione	Motore	Fase	Giri	Rumore	Peso	Dimensioni
Type	Liters	N°	l/min. - C.F.M. - m ³ /h	Bar - Psi	HP - kW	Type	Rpm	dB	Kg - Lbs	cm (LxWxH)
SUPER EXTREME 1 20L.	20	2	130 - 4,6 - 7,8	30 - 435	2,20 - 1,6	Single	1400	72	46 - 102	54 x 60 x 83

With automatic thermal protection
Con protezione termica automatica

SILVERSTONE 12/24 Volt



Packing
Imballo

Weight with box : 7,5 Kg - 16,5 Lbs
Box dimensions : 34 x 16 x 28 (0,016m³)
Quantity EUR PALLET : 100 pcs

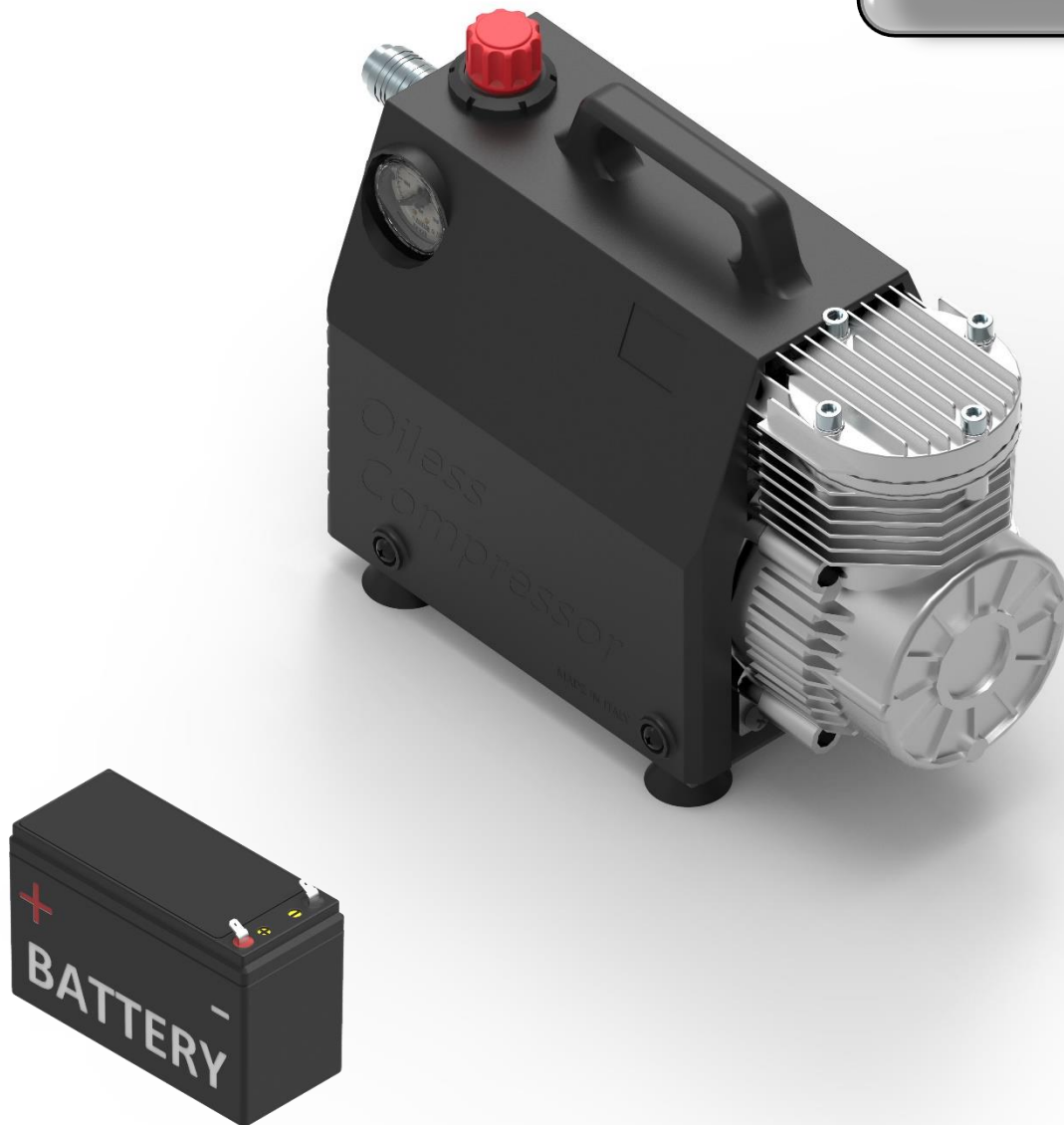

Compressor Model	Tank	Cylinders	Air Intake	Pressure	Power	Phase	Revolution	Noise	Weight	Dimensions
Modello Compressore	Serb.	Cilindri	Aria Aspirata	Pressione	Motore	Fase	Giri	Rumore	Peso	Dimensioni
Type	Liters	N°	l/min. - C.F.M. - m ³ /h	Bar - Psi	WATT	Type	Rpm	dB	Kg - Lbs	cm (LxWxH)
SILVERSTONE 12 VOLT	-	1	100 - 3,5 - 6	8 - 114	450	CC	2800	72	7 - 15,4	33 x 15 x 23
SILVERSTONE 12/24 VOLT	-	1	120 - 4,2 - 7,2 (24V) 60 - 2,1 - 3,6 (12V)	8 - 114	350	CC	3300 1650	74	7 - 15,4	33 x 15 x 23

Packing
Imballo

Weight with box : 11 Kg - 24,2 Lbs
Box dimensions : 41 x 16 x 42 (0,027m³)
Quantity EUR PALLET : 75 pcs

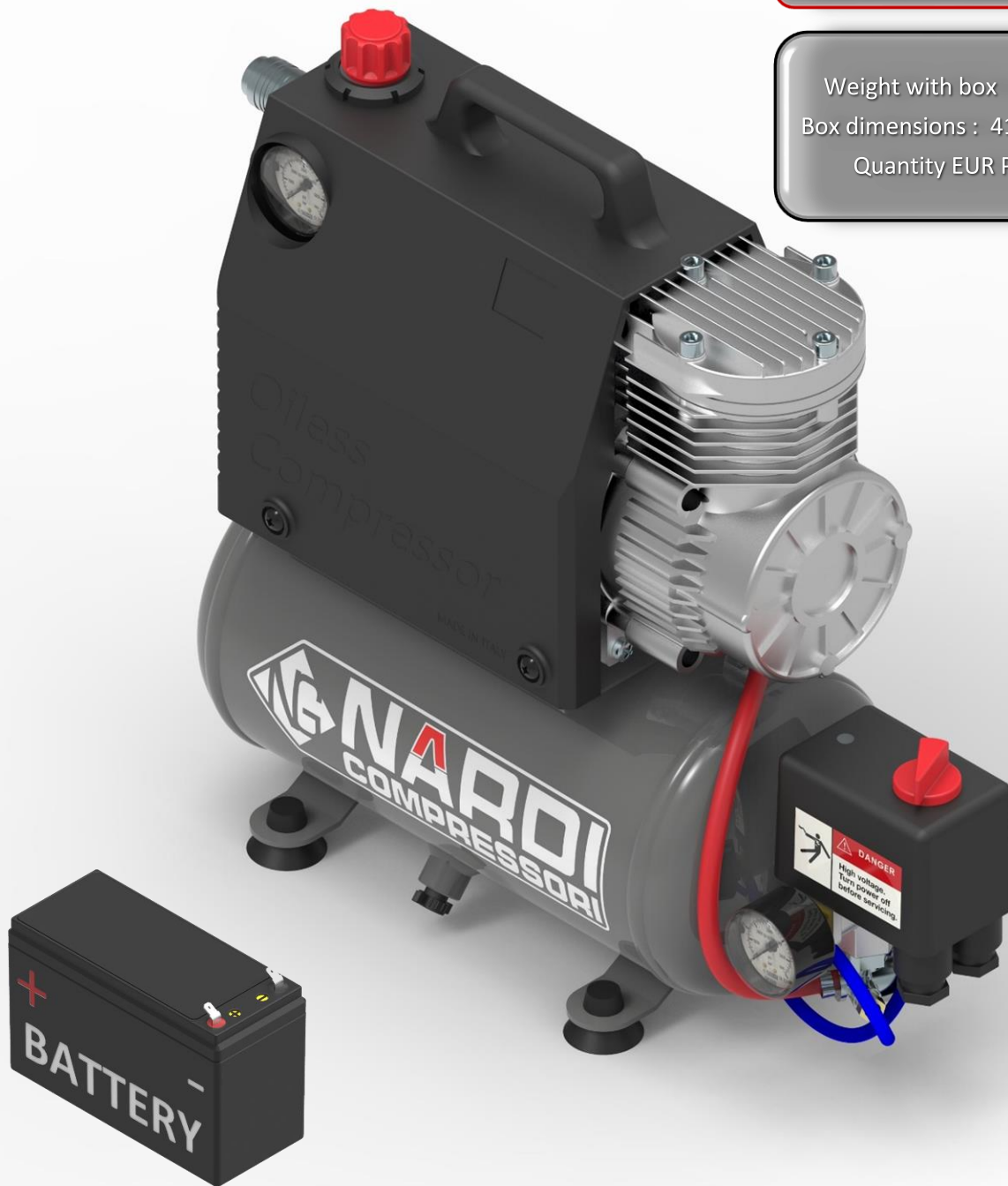

Compressor Model	Tank	Cylinders	Air Intake	Pressure	Power	Phase	Revolution	Noise	Weight	Dimensions
Modello Compressore	Serb.	Cilindri	Aria Aspirata	Pressione	Motore	Fase	Giri	Rumore	Peso	Dimensioni
Type	Liters	N°	l/min. - C.F.M. - m ³ /h	Bar - Psi	Watt	Type	Rpm	dB	Kg - Lbs	cm (LxWxH)
SILVERSTONE 2 12 VOLT	5	1	100 - 3,5 - 6	8 - 114	450	CC	2800	72	10 - 22	41 x 15 x 39
SILVERSTONE 2 12/24 VOLT	5	1	120 - 4,2 - 7,2 (24V) 60 - 2,1 - 3,6 (12V)	8 - 114	350	CC	3300 1650	74	10 - 22	41 x 15 x 39

ESPRIT 3T 12/24 VOLT



**Packing
Imballo**

Weight with box (500 WATT) :
12,5 Kg - 28 Lbs
Box dimensions : 47 x 31 x 33 (0,046m³)
Quantity EUR PALLET : 25 pcs



Compressor Model	Tank	Cylinders	Air Intake	Pressure	Power	Phase	Revolution	Noise	Weight	Dimensions
Modello Compressore	Serb.	Cilindri	Aria Aspirata	Pressione	Motore	Fase	Giri	Rumore	Peso	Dimensioni
Type	Liters	N°	l/min. - C.F.M. - m ³ /h	Bar - Psi	WATT	Type	Rpm	dB	Kg - Lbs	cm (LxWxH)
ESPRIT 3T 60 500W 12 VOLT	3	2	180 - 6,4 - 10,8	10 - 145	500	CC	2400	58	12 - 27	45 x 24 x 28
ESPRIT 3T 60 600W 12 VOLT	3	2	225 - 7,9 - 13,5	10 - 145	600	CC	3000	62	14,5 - 32	45 x 24 x 28
ESPRIT 3T 60 500W 24 VOLT	3	2	225 - 7,9 - 13,5	10 - 145	500	CC	3000	62	14,5 - 32	45 x 24 x 28

Packing
Imballo

Weight with box (500 WATT) :

18,5 Kg - 41 Lbs

Box dimensions : 51 x 25 x 43 (0,055m³)

Quantities EUROPALET : 24 pcs

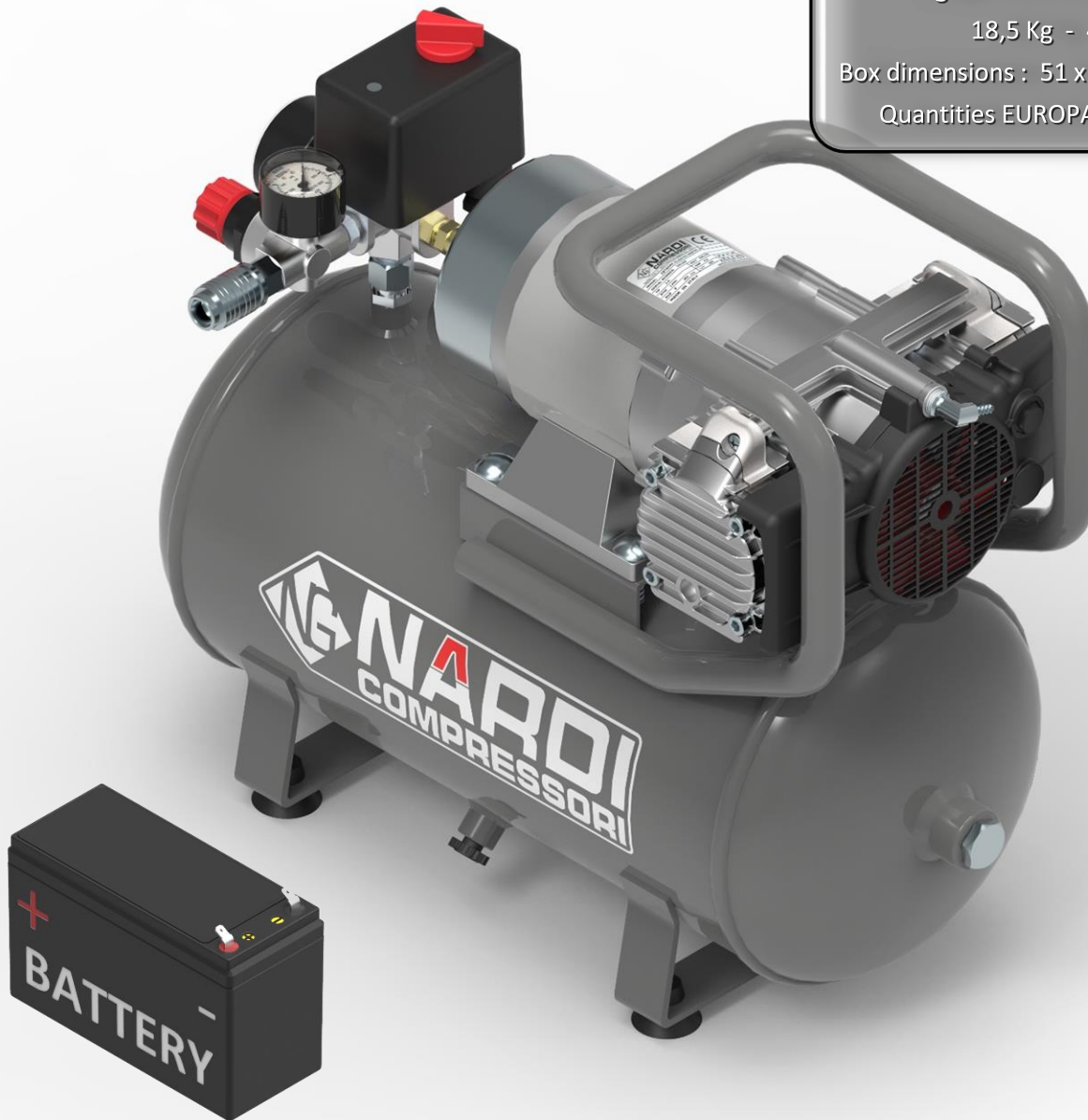

Compressor Model	Tank	Cylinders	Air Intake	Pressure	Power	Phase	Revolution	Noise	Weight	Dimensions
Modello Compressore	Serb.	Cilindri	Aria Aspirata	Pressione	Motore	Fase	Giri	Rumore	Peso	Dimensioni
Type	Liters	N°	l/min. - C.F.M. - m ³ /h	Bar - Psi	Watt	Type	Rpm	dB	Kg - Lbs	cm (LxWxH)
ESPRIT 3 60 500W 12 VOLT	15	2	180 - 6,4 - 10,8	10 - 145	500	CC	2400	58	12 - 27	47 x 22 x 40
ESPRIT 3 60 600W 12 VOLT	15	2	225 - 7,9 - 13,5	10 - 145	600	CC	3000	62	14,5 - 32	47 x 22 x 40
ESPRIT 3 60 500W 24 VOLT	15	2	225 - 7,9 - 13,5	10 - 145	500	CC	3000	62	14,5 - 32	47 x 22 x 40

EXTREME 3 7L. 12/24 Volt



Packing
Imballo

Weight with box : 23,5 Kg - 52 Lbs
Box dimensions : 44 x 44 x 50 (0,097m³)
Quantity EUR PALLET : 18 pcs

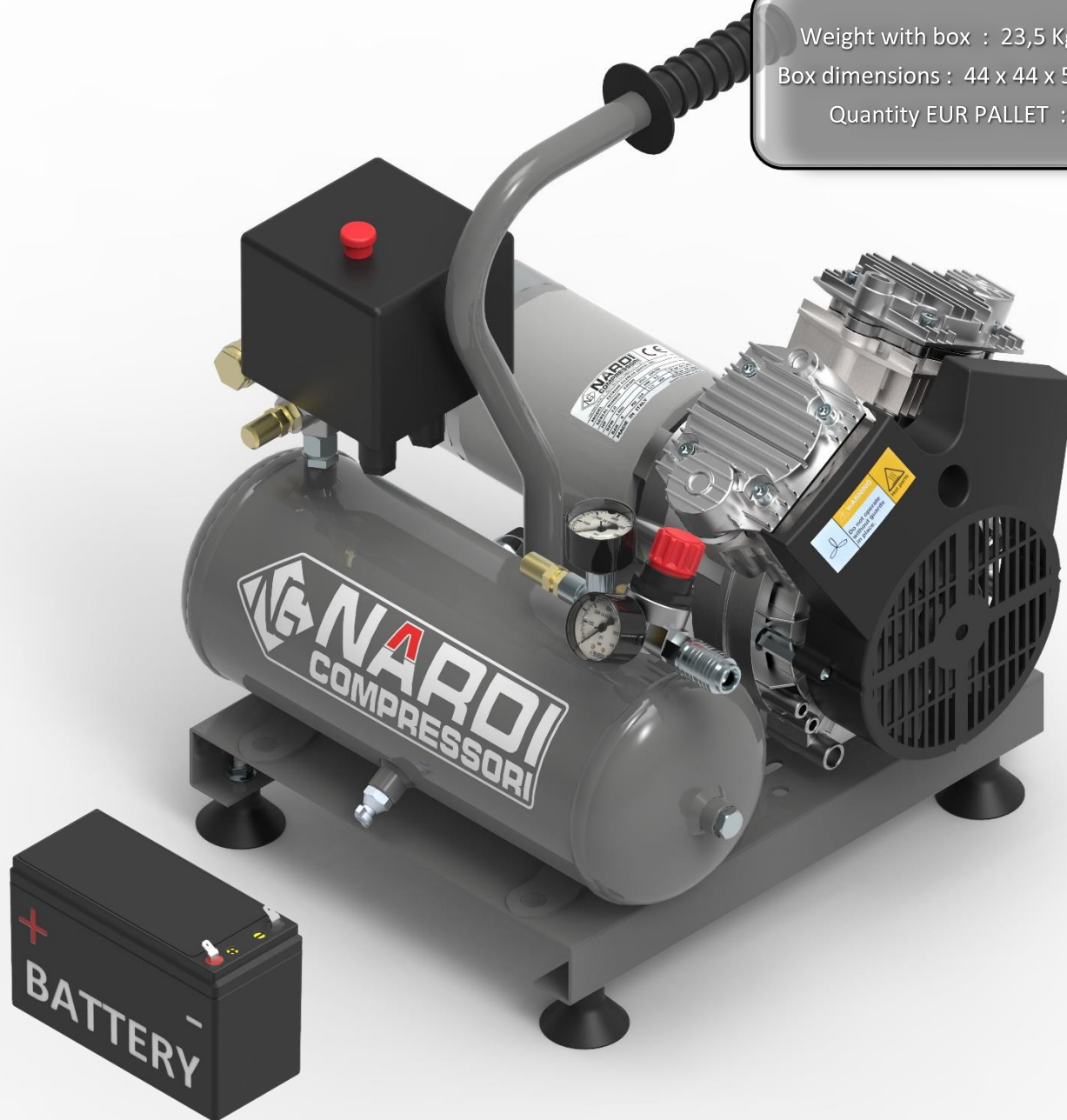

Compressor Model	Tank	Cylinders	Air Intake	Pressure	Power	Phase	Revolution	Noise	Weight	Dimensions
Modello Compressore	Serb.	Cilindri	Aria Aspirata	Pressione	Motore	Fase	Giri	Rumore	Peso	Dimensioni
Type	Liters	N°	l/min. - C.F.M. - m ³ /h	Bar - Psi	WATT - AMP	Type	Rpm	dB	Kg - Lbs	cm (LxWxH)
EXTREME 3 7L. 12 VOLT	7	2	250 - 8,8 - 15	8 - 114	800 - 85	CC	2400	72	22,5 - 50	41 x 40 x 40
EXTREME 3 7L. 24 VOLT	7	2	250 - 8,8 - 15	8 - 114	800 - 40	CC	2600	72	22,5 - 50	41 x 40 x 40

Packing
Imballo

Weight with box :32 Kg - 71 Lbs
Box dimensions : 75 x 28 x 58 (0,122 m³)
Quantity EUR PALLET : 12 pcs



Compressor Model	Tank	Cylinders	Air Intake	Pressure	Power	Phase	Revolution	Noise	Weight	Dimensions
Modello Compressore	Serb.	Cilindri	Aria Aspirata	Pressione	Motore	Fase	Giri	Rumore	Peso	Dimensioni
Type	Liters	N°	l/min. - C.F.M. - m ³ /h	Bar - Psi	HP - kW	Type	Rpm	dB	Kg - Lbs	cm (LxWxH)
EXTREME 3 30L. 12 VOLT	30	2	250 - 8,8 - 15	8 - 114	800 - 85	CC	2400	72	28 - 62	70 x 30 x 60
EXTREME 3 30L. 12/24 VOLT	30	2	250 - 8,8 - 15	8 - 114	800 - 40	CC	2600	72	28 - 62	70 x 30 x 60

EXTREME 5G 7L. GASOLINE



Packing
Imballo

Weight with box : 26,5 Kg - 59 Lbs
Box dimensions : 50 x 48 x 48 (0,100m³)
Quantity EUR PALLET : 24 pcs



Compressor Model	Tank	Cylinders	Air Intake	Pressure	Power	Phase	Revolution	Noise	Weight	Dimensions
Modello Compressore	Serb.	Cilindri	Aria Aspirata	Pressione	Motore	Fase	Giri	Rumore	Peso	Dimensioni
Type	Liters	N°	l/min. - C.F.M. - m ³ /h	Bar - Psi	Cv	Type	Rpm	dB	Kg - Lbs	cm (LxWxH)
EXTREME 5G 3,00 CV	7	2	270 - 9,5 - 16,2	10 - 145	3,00	Gasoline	3000	85	25,5 - 56	42 x 45 x 45
EXTREME 5G 70 3,00 CV	7	2	380 - 13,4 - 22,8	10 - 145	3,00	Gasoline	3000	85	26,5 - 59	42 x 45 x 45

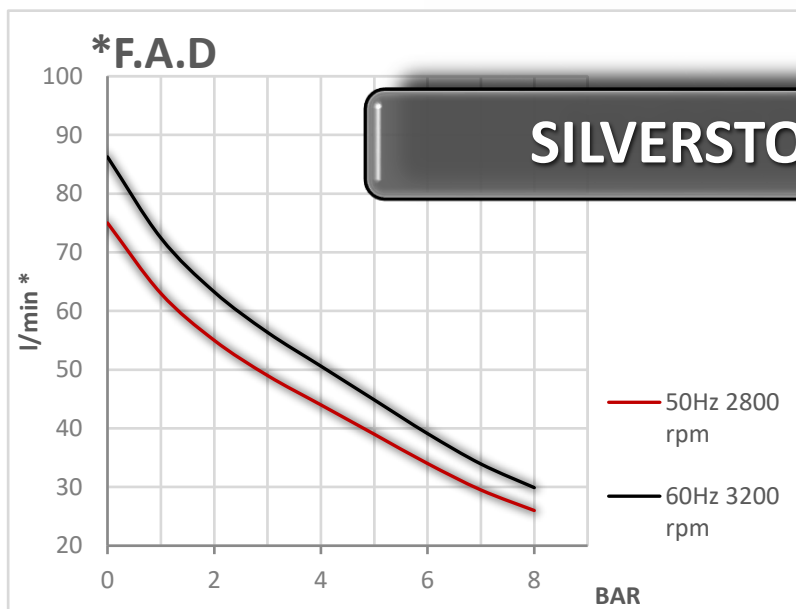

Compressor Model	Cylinders	Air Intake	Pressure	Power	Phase	Revolution	Noise	Weight	Dimensions
Modello Compressore	Cilindri	Aria Aspirata	Pressione	Motore	Fase	Giri	Rumore	Peso	Dimensioni
Type	N°	l/min. - C.F.M. - m³/h	Bar - Psi	HP - kW	Type	Rpm	dB	Kg - Lbs	cm (LxWxH)
SILVERSTONE UNIT	1	100 - 3,5 - 6 (50 Hz) 120 - 4,2 - 7,2 (60 Hz)	8 - 114	0,5 - 0,35	Single	2800 3300	72	5,5 - 12	23 x 14 x 18

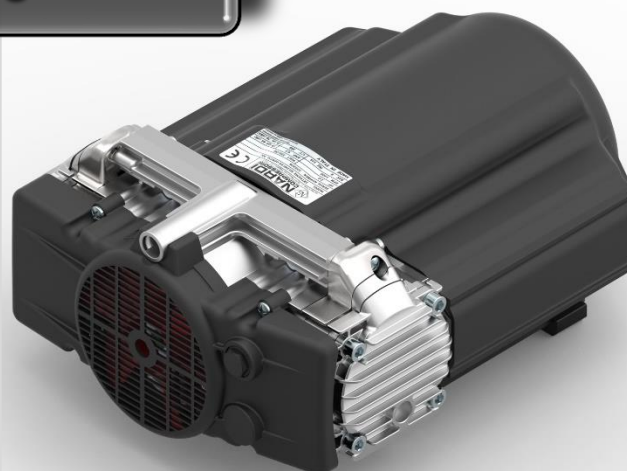
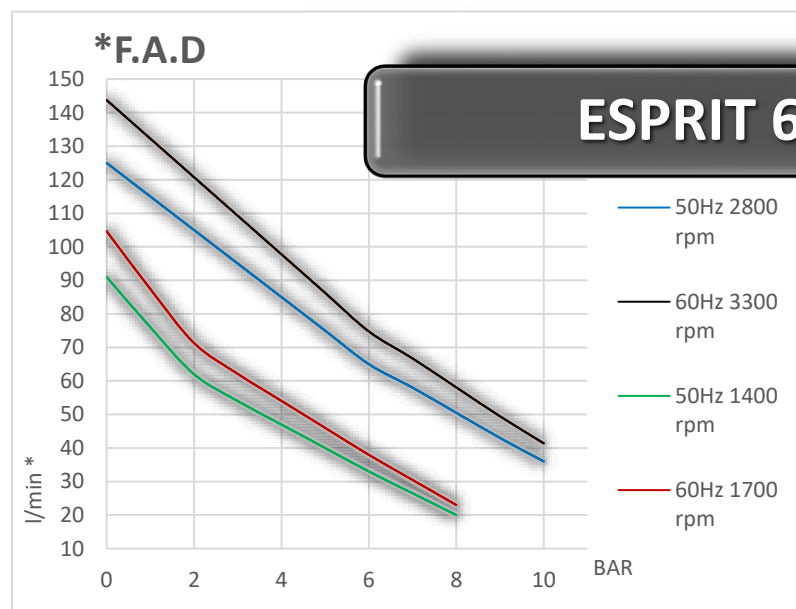

Compressor Model	Cylinders	Air Intake	Max Pressure	Power	Phase	Revolution	Noise	Weight	Dimensions
Modello Compressore	Cilindri	Aria Aspirata	Pressione mass.	Motore	Fase	Giri	Rumore	Peso	Dimensioni
Type	N°	l/min. - C.F.M. - m³/h	Bar - Psi	HP - kW	Type	Rpm	dB	Kg - Lbs	cm (LxWxH)
ESPRIT UNIT 60/4	2	105 - 3,7 - 6,3 (50 Hz) 125 - 4,4 - 7,5 (60 Hz)	8 - 114	0,75 - 0,5	Single	1400 1700	48	8 - 17	29 x 22 x 14
ESPRIT UNIT 60/2	2	210 - 7,4 - 12,6 (50 Hz) 250 - 8,8 - 15 (60 Hz)	10 - 145	0,75 - 0,5	Single	2800 3300	55	8 - 17	29 x 22 x 14

With automatic thermal protection - * F.A.D. values have a tolerance $\pm 5\%$

PUMP UNIT

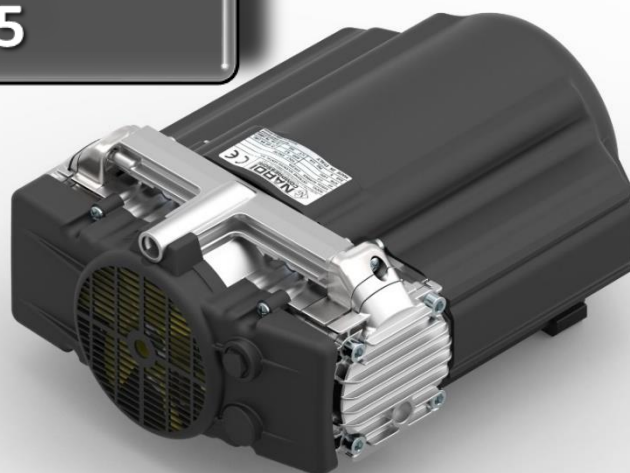
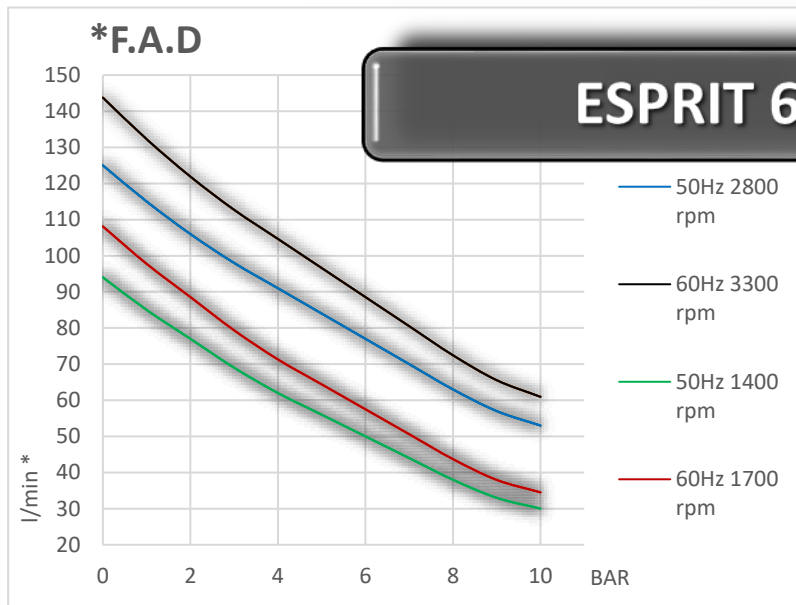

Compressor Model	Cylinders	Air Intake	Pressure	Power	Phase	Revolution	Noise	Weight	Dimensions
Modello Compressore	Cilindri	Aria Aspirata	Pressione	Motore	Fase	Giri	Rumore	Peso	Dimensioni
Type	N°	l/min. - C.F.M. - m³/h	Bar - Psi	HP - kW	Type	Rpm	dB	Kg - Lbs	cm (LxWxH)
ESPRIT UNIT 65/4	2	125 - 4,4 - 7,5 (50 Hz) 150 - 5,3 - 9 (60 Hz)	8 - 114	0,90 - 0,65	Single	1400 1700	49	8,5 - 19	29 x 22 x 14
ESPRIT UNIT 65/2	2	250 - 8,8 - 15 (50 Hz) 300 - 10,5 - 18 (60 Hz)	8 - 114	0,90 - 0,65	Single	2800 3300	56	8,5 - 19	29 x 22 x 14

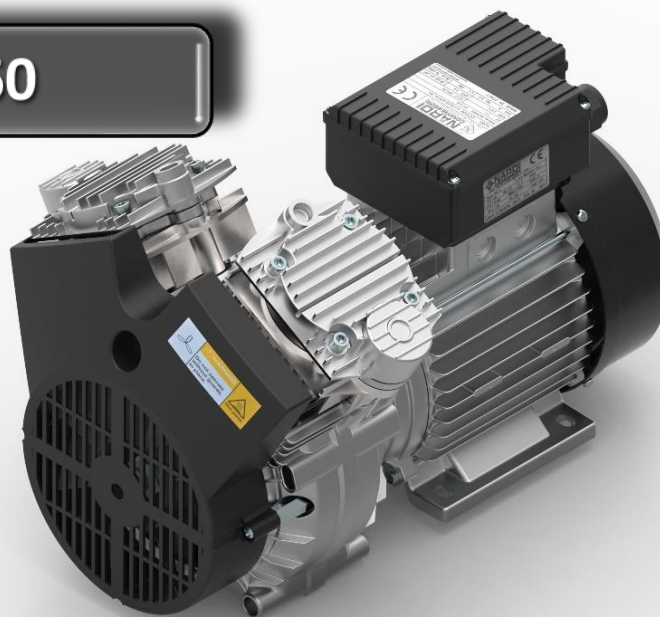
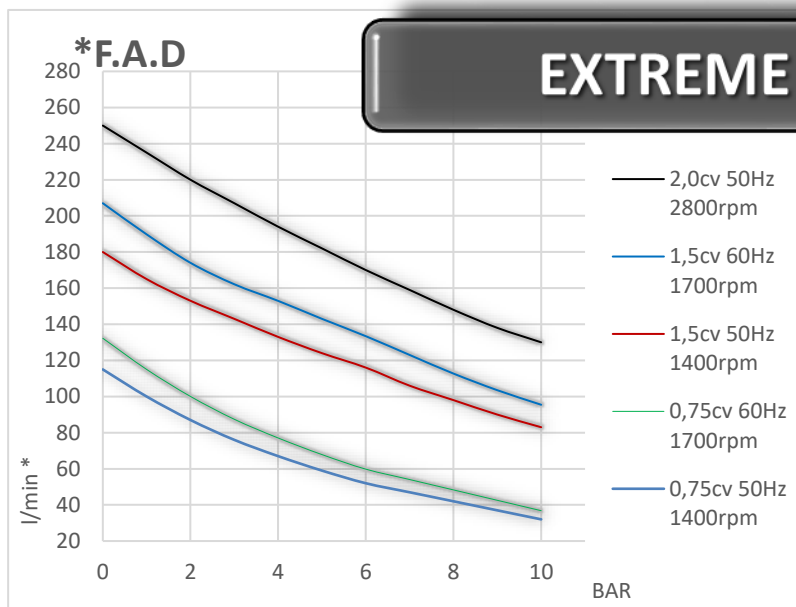

Compressor Model	Cylinders	Air Intake	Max Pressure	Power	Phase	Revolution	Noise	Weight	Dimensions
Modello Compressore	Cilindri	Aria Aspirata	Pressione mass.	Motore	Fase	Giri	Rumore	Peso	Dimensioni
Type	N°	l/min. - C.F.M. - m³/h	Bar - Psi	HP - kW	Type	Rpm	dB	Kg - Lbs	cm (LxWxH)
EXTREME UNIT 0,75 HP	2	200 - 7,0 - 12 (50 Hz) 240 - 8,5 - 14,4 (60 Hz)	10 - 145	0,75 - 0,55	Single	1400 1700	72	14 - 31	39 x 28 x 26
EXTREME UNIT 1,50 HP	2	240 - 8,5 - 14,4 (50 Hz) 290 - 10,1 - 17,2 (60 Hz)	10 - 145	1,50 - 1,1	Single	1400 1700	72	16,5 - 36	39 x 28 x 26
EXTREME UNIT 2,00 HP	2	400 - 14,1 - 24 (50 Hz)	10 - 145	2,00 - 1,5	Single	2800	82	19,5 - 43	40 x 28 x 26

Con protezione termica automatica - * I valori indicati hanno una tolleranza $\pm 5\%$

MADE IN ITALY BY NARDI COMPRESSORI

Page 38

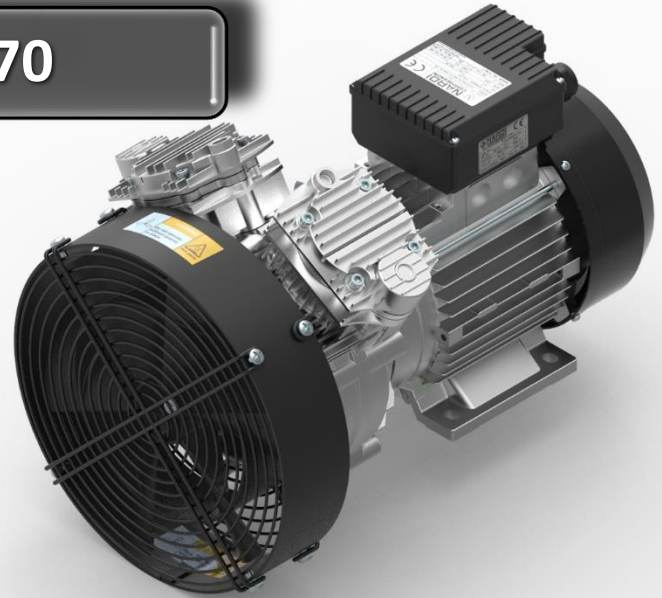
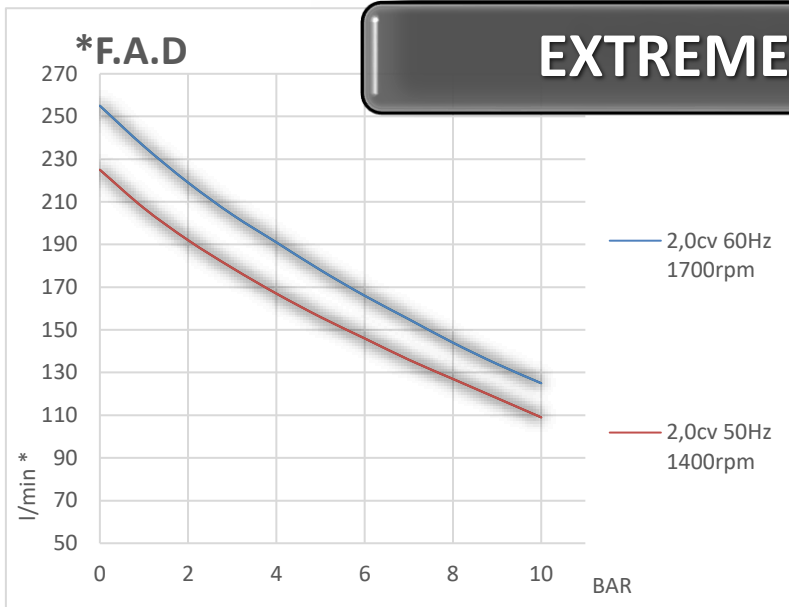

Compressor Model	Cylinders	Air Intake	Max Pressure	Power	Phase	Revolution	Noise	Weight	Dimensions
Modello Compressore	Cilindri	Aria Aspirata	Pressione mass.	Motore	Fase	Giri	Rumore	Peso	Dimensioni
Type	N°	l/min. - C.F.M. - m³/h	Bar - Psi	HP - kW	Type	Rpm	dB	Kg - Lbs	cm (LxWxH)
EXTREME UNIT 2,00 HP	2	350 - 12,4 - 21 (50 Hz)	10 - 145	2,00 - 1,5	Single	1400 1700	72	21 - 47	43 x 28 x 29

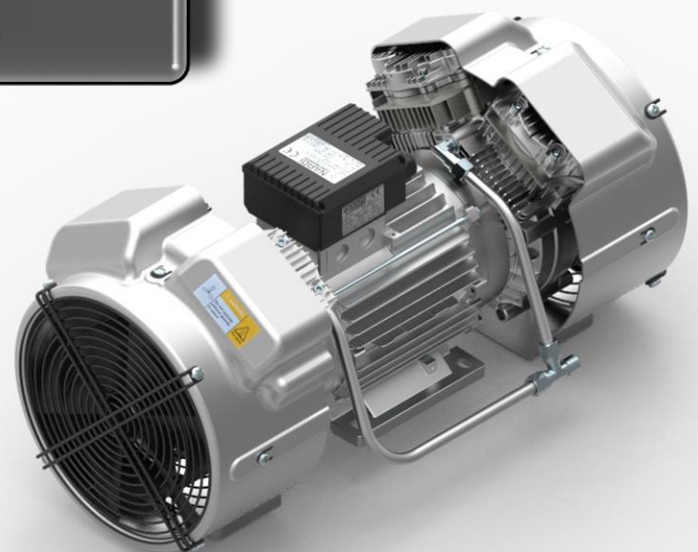
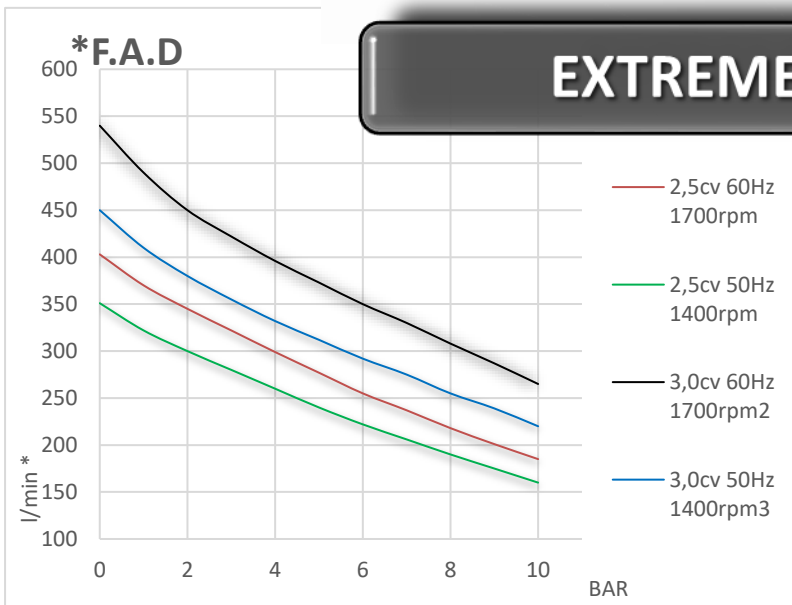

Compressor Model	Cylinders	Air Intake	Max Pressure	Power	Phase	Revolution	Noise	Weight	Dimensions
Modello Compressore	Cilindri	Aria Aspirata	Pressione mass.	Motore	Fase	Giri	Rumore	Peso	Dimensioni
Type	N°	l/min. - C.F.M. - m³/h	Bar - Psi	HP - kW	Type	Rpm	dB	Kg - Lbs	cm (LxWxH)
EXTREME 4 UNIT 2,5HP	4	480 - 17 - 29 (50 Hz) 580 - 20 - 35 (60 Hz)	10 - 145	2,50 - 1,9	Single	1400 1700	73	30 - 66	61 x 28 x 31
EXTREME 4 UNIT 3,0HP	4	600 - 21,2 - 36 (50 Hz) 720 - 25,5 - 43 (60 Hz)	10 - 145	3,00 - 2,2	Three	1400 1700	73	33 - 73	64 x 28 x 31

With automatic thermal protection - * F.A.D. values have a tolerance $\pm 5\%$

PUMP UNIT

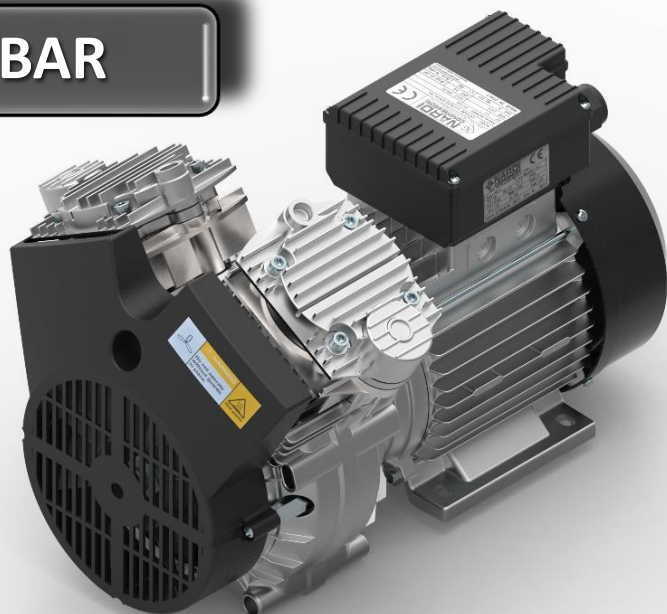
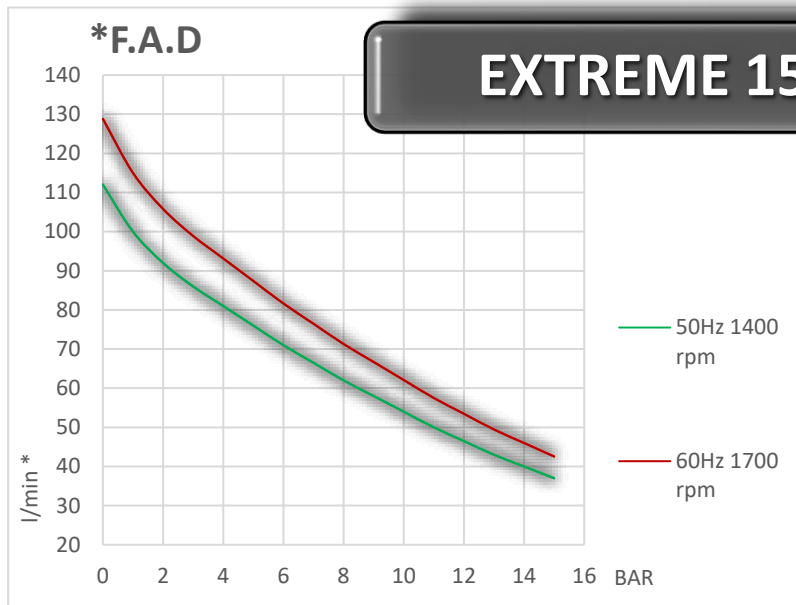

Compressor Model	Cylinders	Air Intake	Max Pressure	Power	Phase	Revolution	Noise	Weight	Dimensions
Modello Compressore	Cilindri	Aria Aspirata	Pressione mass.	Motore	Fase	Giri	Rumore	Peso	Dimensioni
Type	N°	l/min. - C.F.M. - m³/h	Bar - Psi	HP - kW	Type	Rpm	dB	Kg - Lbs	cm (LxWxH)
EXTREME 15 BAR	2	115 - 4,0 - 6,9 (50 Hz) 145 - 5,0 - 8,7 (60 Hz)	15 - 217	1,50 - 1,1	Single	1400 1700	73	16,5 - 36	39 x 28 x 26

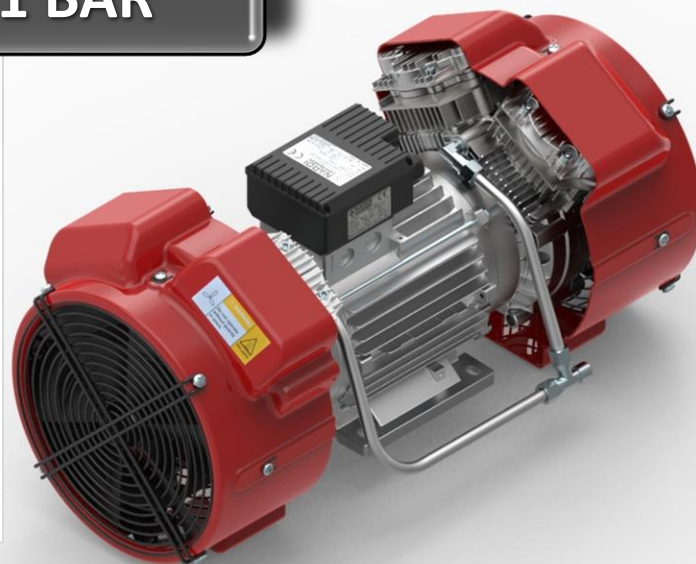
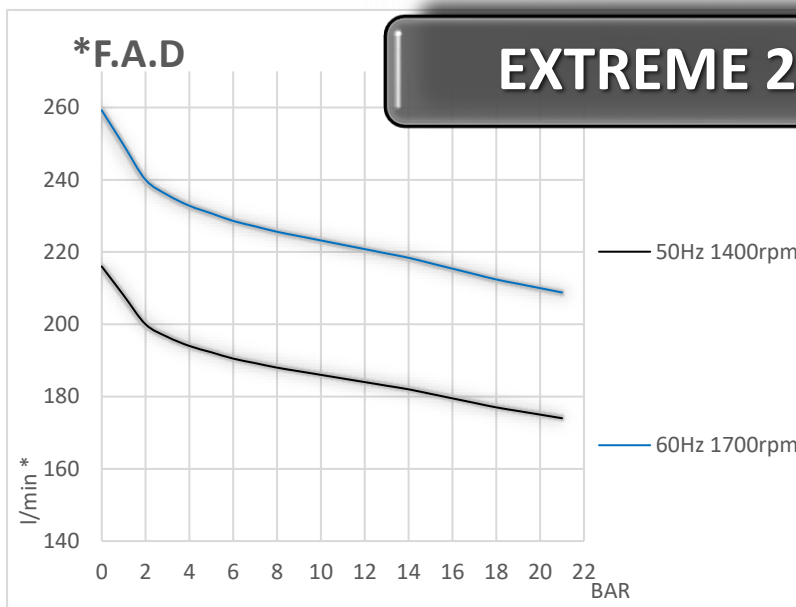

Compressor Model	Cylinders	Air Intake	Max Pressure	Power	Phase	Revolution	Noise	Weight	Dimensions
Modello Compressore	Cilindri	Aria Aspirata	Pressione mass.	Motore	Fase	Giri	Rumore	Peso	Dimensioni
Type	N°	l/min. - C.F.M. - m³/h	Bar - Psi	HP - kW	Type	Rpm	dB	Kg - Lbs	cm (LxWxH)
EXTREME 21 BAR	4	260 - 9,2 - 15,6 (50 Hz) 312 - 11 - 18,7 (60 Hz)	21 - 305	3,00 - 2,2	Three	1400 1700	72	33 - 73	64 x 28 x 31

Con protezione termica automatica - * I valori indicati hanno una tolleranza $\pm 5\%$

MADE IN ITALY BY NARDI COMPRESSORI

Page 40

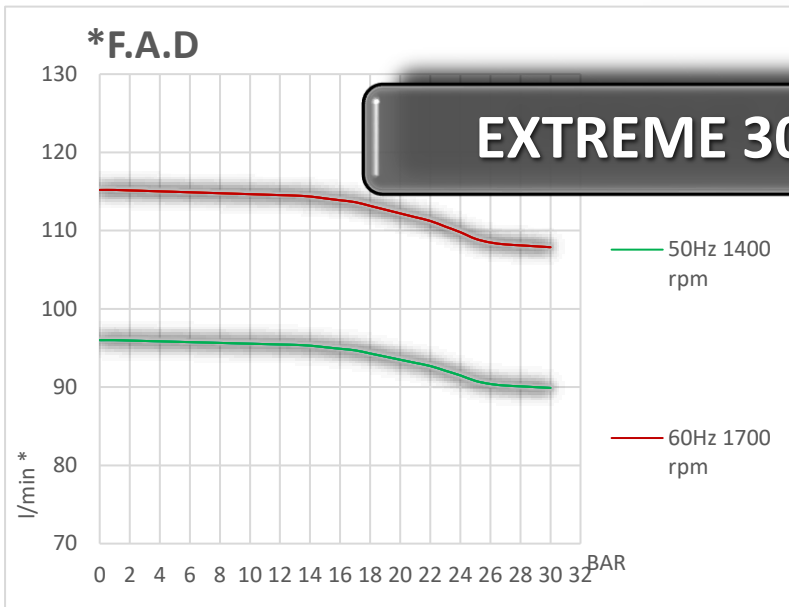

Compressor Model	Cylinders	Air Intake	Max Pressure	Power	Phase	Revolution	Noise	Weight	Dimensions
Modello Compressore	Cilindri	Aria Aspirata	Pressione mass.	Motore	Fase	Giri	Rumore	Peso	Dimensioni
Type	N°	l/min. - C.F.M. - m³/h	Bar - Psi	HP - kW	Type	Rpm	dB	Kg - Lbs	cm (LxWxH)
EXTREME 30 BAR	2	130 - 4,6 - 7,8 (50 Hz) 156 - 5,5 - 9,4 (60 Hz)	30 - 435	2,2 - 1,6	Single	1400 1700	72	18 - 40	39 x 28 x 26

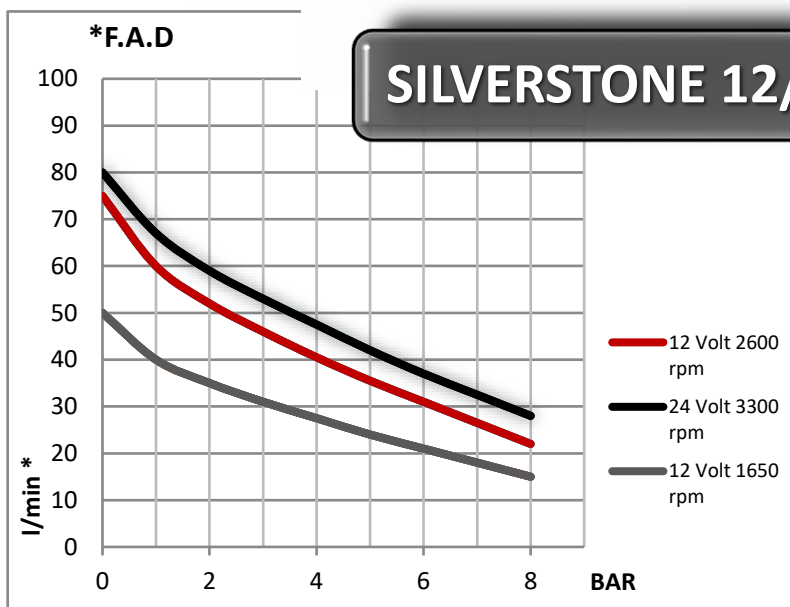

Compressor Model	Cylinders	Air Intake	Max Pressure	Power	Phase	Revolution	Noise	Weight	Dimensions
Modello Compressore	Cilindri	Aria Aspirata	Pressione mass.	Motore	Fase	Giri	Rumore	Peso	Dimensioni
Type	N°	l/min. - C.F.M. - m³/h	Bar - Psi	Watt	Type	Rpm	dB	Kg - Lbs	cm (LxWxH)
SILVERSTONE 12 VOLT	1	95 - 3,4 - 5,7 (12V)	8 - 114	450	CC	2600	72	6 - 13	25 x 14 x 19
SILVERSTONE 24 VOLT	1	120 - 4,2 - 7,2 (24V) 60 - 2 - 3,4 (12V)	8 - 114	350	CC	3300 1650	72	6 - 13	25 x 14 x 19

With automatic thermal protection - * F.A.D. values have a tolerance $\pm 5\%$

PUMP UNIT

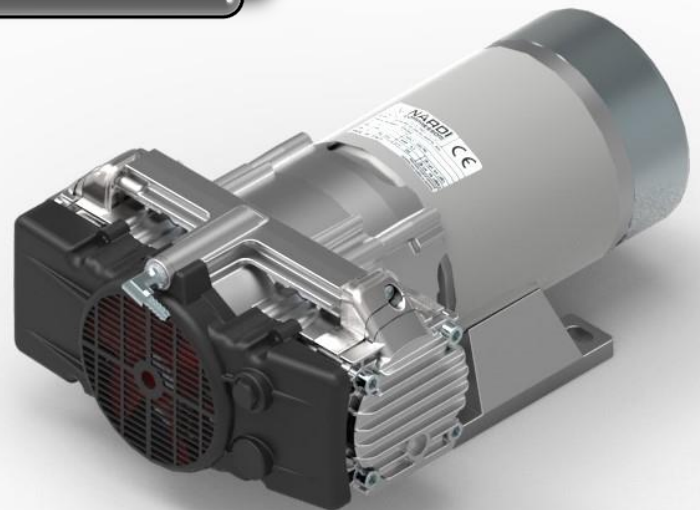
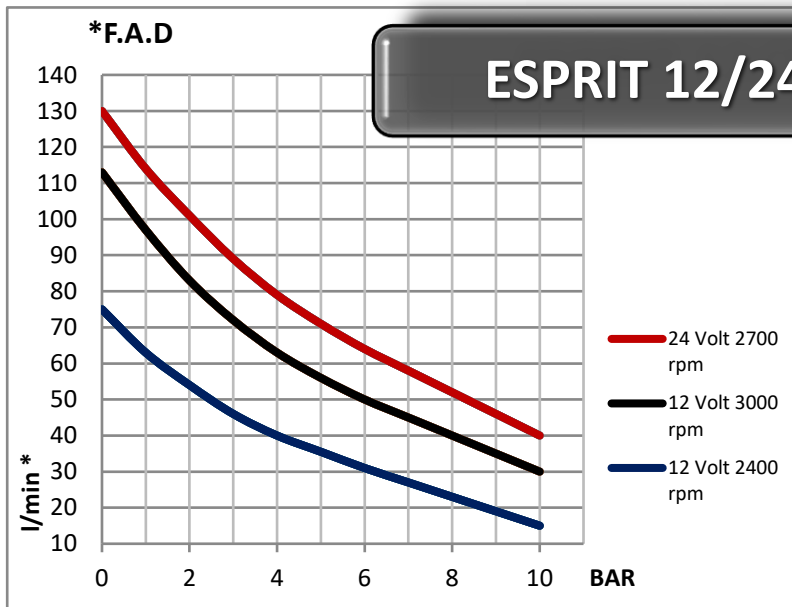

Compressor Model	Cylinders	Air Intake	Max Pressure	Power	Phase	Revolution	Noise	Weight	Dimensions
Modello Compressore	Cilindri	Aria Aspirata	Pressione mass.	Motore	Fase	Giri	Rumore	Peso	Dimensioni
Type	N°	l/min. - C.F.M. - m³/h	Bar - Psi	Watt	Type	Rpm	dB	Kg - Lbs	cm (LxWxH)
ESPRIT 500W 12 VOLT	2	180 – 6,4 – 10,8 (12V)	10 – 145	500	CC	2400	50	7 – 15	28 x 22 x 14
ESPRIT 600W 12 VOLT	2	225 – 7,9 – 13,5 (12V)	10 – 145	600	CC	3000	52	8 – 18	32 x 22 x 14
ESPRIT 500W 24 VOLT	2	225 – 7,9 – 13,5 (24V) 112 – 3,9 – 6,7 (12V)	10 – 145	500	CC	2700 1350	52	8 – 18	32 x 22 x 14

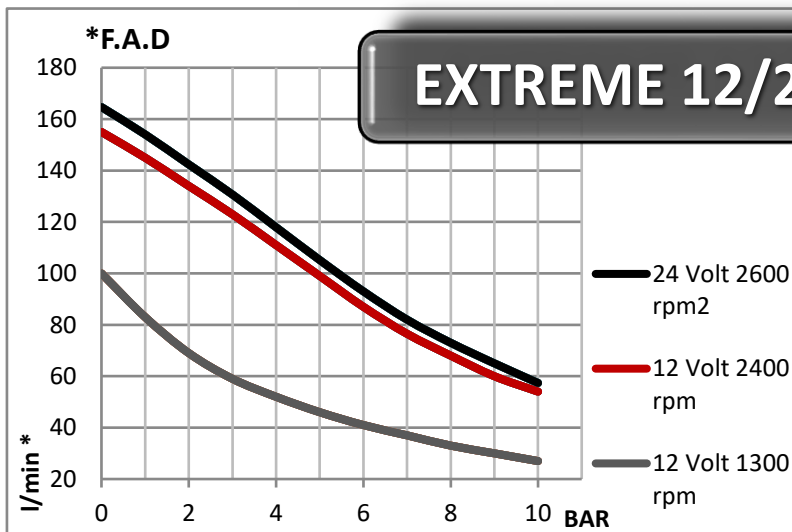

Compressor Model	Cylinders	Air Intake	Max Pressure	Power	Phase	Revolution	Noise	Weight	Dimensions
Modello Compressore	Cilindri	Aria Aspirata	Pressione mass.	Motore	Fase	Giri	Rumore	Peso	Dimensioni
Type	N°	l/min. - C.F.M. - m³/h	Bar - Psi	Watt	Type	Rpm	dB	Kg - Lbs	cm (LxWxH)
EXTREME 12 VOLT	2	260 – 8,4 – 14 (12V)	10 – 145	800	CC	2400	72	13 – 29	29 x 22 x 14
EXTREME 24 VOLT	2	280 – 8,4 – 14 (24V) 140 – 4,2 – 7 (12V)	10 – 145	800	CC	2600 1300	80	13 – 29	29 x 22 x 14

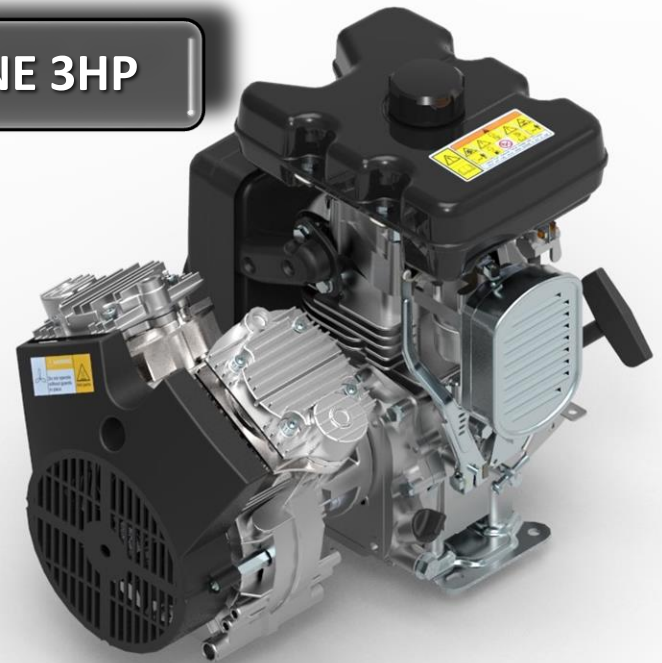
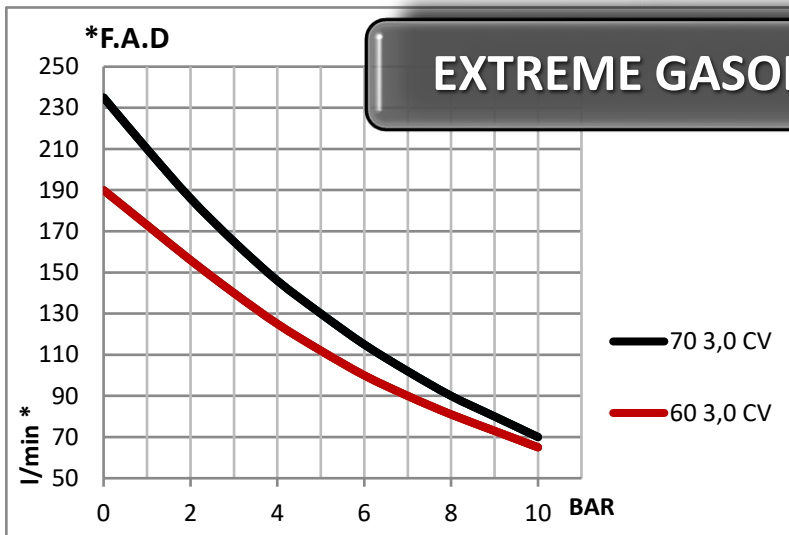

Compressor Model	Cylinders	Air Intake	Max Pressure	Power	Revolution	Noise	Weight	Dimensions
Modello Compressore	Cilindri	Aria Aspirata	Pressione mass.	Motore	Giri	Rumore	Peso	Dimensioni
Type	N°	l/min. - C.F.M. - m³/h	Bar - Psi	HP	Rpm	dB	Kg - Lbs	cm (LxWxH)
EXTREME ROBIN 60 3,00 HP	2	270 - 9,5 - 16,2	10 - 145	3,00	2900	85	13 - 29	45 x 24 x 28
EXTREME ROBIN 70 3,00 HP	2	380 - 13,4 - 22,8	10 - 145	3,00	2900	85	13 - 29	45 x 24 x 28



Compressor Model	Cylinders	Air Intake	Max Pressure	Power	Revolution	Noise	Weight	Dimensions
Modello Compressore	Cilindri	Aria Aspirata	Pressione mass.	Motore	Giri	Rumore	Peso	Dimensioni
Type	N°	l/min. - C.F.M. - m³/h	Bar - Psi	HP	Rpm	dB	Kg - Lbs	cm (LxWxH)
EXTREME ROBIN 60 6,00 HP	2	510 - 19 - 30,5	10 - 145	6,00	2900	85	18 - 39	55 x 29 x 33
EXTREME ROBIN 47 6,00 HP	2	340 - 12,6 - 20,4	15 - 217	6,00	2900	85	18 - 39	55 x 29 x 33

Standard Delivery

Fornitura standard

Standard Volt/Hertz/Phase : 230/50/1
Other : 100⇒240 Volt/50-60 Hz/1 Phase

STANDARD COLOR : GREY
Other colors min. delivery : 50 pcs

Standard plug :
SCHUKO

Standard fitting :
1/4" G BALL VALVE

General Sales Conditions (ENGLISH)

- This catalogue cancels and substitutes the previous versions.
- Once order is confirmed all sales conditions entered in our OC are implicitly accepted.
- The goods are always delivered ex works and at the buyer's risk.
- Any possible complaints about packing or delivery are accepted only if notified within 8 days from date of receipt.
- Our production is warranted for 24 months from the delivery of the goods. Warranty is excluded for improper use and consequent damages. Warranty is guaranteed only for manufacturing fault.
- Transport costs are always and completely incurred by buyers.
- Delivery terms shall always be considered as approximate. Shortage of all, or part, of the goods on delivery cannot rise any claims unless terms have been previously agreed in writing.
- All data and technical aspects cited in this catalogue are not binding and may be altered by NARDI COMPRESSORI without notice due to technical or manufacturing necessities.
- The invoice referring to the delivered goods shall be paid according to the terms agreed. Any delay in payments will enforce extra charges.
- In case of disputes, jurisdiction will be the court of Vicenza – Italy.
- This catalogue belongs exclusively to NARDI COMPRESSORI SRL situated in Montecchio Maggiore (VI) Italy; reproduction or copying of the goods, or any part of the catalogue, without the company's permission is strictly forbidden.

Condizioni generali di vendita (ITALIANO)

- Il presente catalogo annulla e sostituisce il precedente.
- Con il conferimento dell'ordine si considerano accettate tutte le condizioni di vendita.
- La merce si considera franco nostra fabbrica. La merce viaggia sempre a rischio e pericolo dell'acquirente che ha l'obbligo di ritirarla.
- Non si accettano reclami su imballi o spedizioni se non fatti entro 8 giorni dalla consegna della merce.
- I nostri prodotti sono coperti di garanzia per 24 mesi dalla consegna della merce. Non sono garantiti i danni provocati da usura, cattivo uso e non ci assumiamo nessuna responsabilità per danni diretti o indiretti derivanti da tale cattivo uso. La garanzia è valida solo per difetti di fabbricazione.
- Tutti i costi di trasporto sono sempre e completamente a carico del cliente.
- I termini di consegna non sono mai impegnati. La mancata consegna di parte o tutta l'ordinazione non può dar luogo ad alcuna rivalsa di danni verso la nostra ditta, salvo diverse attuazioni scritte e regolarmente accettate.
- Tutti i dati e le indicazioni tecniche citate nel presente catalogo non sono impegnativi e potranno essere modificati in caso di necessità tecniche o produttive, senza alcun preavviso.
- Per pagamenti effettuati oltre la scadenza pattuita saranno addebitati l'interessi moratori al tasso corrente bancario.
- In caso di controversia è riconosciuta la sola competenza del tribunale di Vicenza.
- Questo catalogo è di proprietà esclusiva della ditta Nardi Compressori Srl con sede a Montecchio Maggiore (VI) e senza il consenso della stessa ditta non può essere né copiato, né riprodotto anche solo parzialmente sotto pena delle sanzioni di legge in materia.

This catalogue replaced the previous one

Questo catalogo sostituisce i precedenti

MADE IN ITALY BY NARDI COMPRESSORI

Page 44

Nardi Compressori ITALY

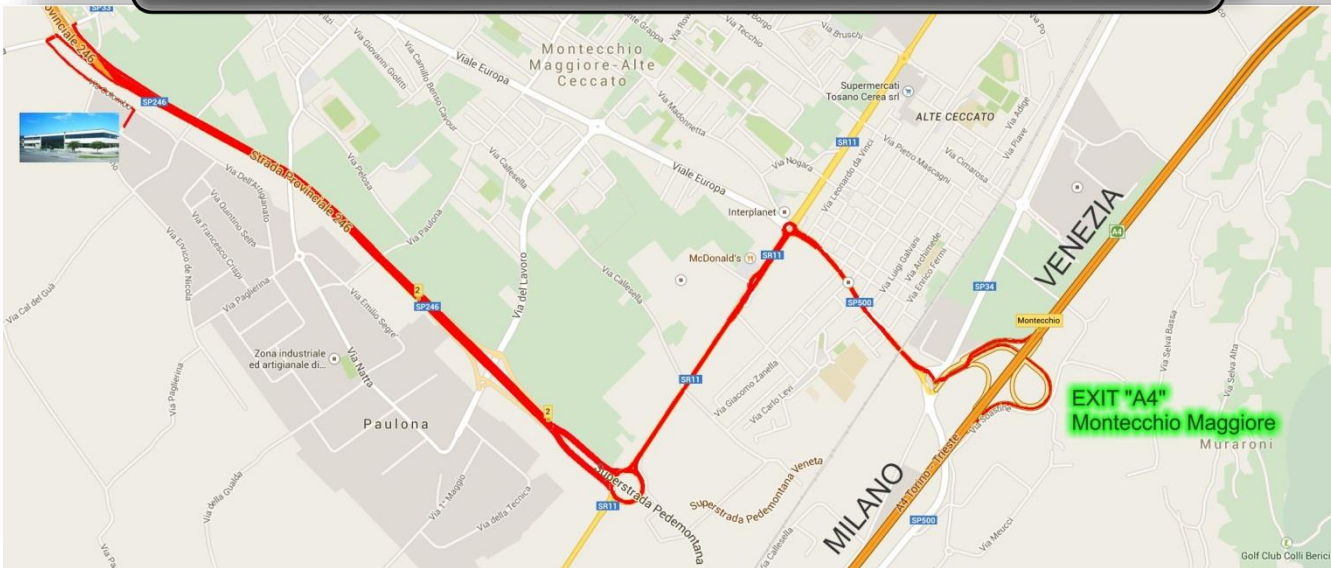

Connection

	Railway station VICENZA		15 Km
	Airport VERONA "Villafranca"	VRN	55 Km
	Airport VENICE "Marco Polo"	VCE	83 Km
	Airport MILAN "Orio al Serio"	BGY	150 Km
	Airport BOLOGNA "Marconi"	BLQ	170 Km
	Airport MILAN "Linate"	LIN	200 Km
	Airport MILAN "Malpensa"	MLX	230 Km

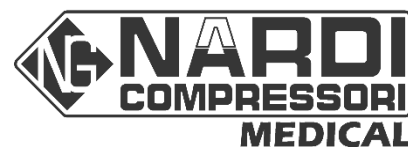

A complete line of oil-less Low Pressure compressors with maximum working pressure of 10 Bar. These compressors have different tanks capacity up to a maximum of 500 liters. Power includes single phase and 3-phase AC electric motors.



High Pressure compressors up to 450 Bar for the filling of cylinders for breathing air, used often for scuba diving and by fire stations for fire and rescue operations as well as for military applications.



High Pressure compressors and Boosters up to 450 Bar. Technical gas compressors with high degree of purity for industrial use, the range is completed by the supply of High Pressure cylinders for storage in different capacity and configuration.



High Pressure compressors for refueling of vehicles that run on natural gas. Compressors in this line have been designed for Industrial and domestic use, creating simple and economic small refueling stations for private utility using gas supplied through the network lines.





Nardi Compressori Srl
Via Marco Polo, 2 36075
Montecchio Maggiore (VICENZA) ITALY
Tel. +39.0444.159111 - 497514 -694885
Fax. +39.0444.159122
Mail. info@nardicompressori.com



www.nardicompressori.com



www.facebook.com/nardicompressorisrl/



[nardi compressori](https://twitter.com/nardi_compressori)



[+39 340 874 3122](https://wa.me/393408743122)